





F.A.T.
THE MANUAL

The F.A.T. Manual

Edited by: Domenico Quaranta, Geraldine Juárez

Designed by: Fabio Paris

Published by: Link Editions, Brescia 2013

www.linkartcenter.eu

Co-produced by: F.A.T. Lab, MU

On the occasion of the exhibition:

**F.A.T. GOLD Europe, MU, Eindhoven,
November 15, 2013 - January 26, 2014**

With generous support from:

Baltan Laboratories, Eindhoven



**BALTAN
LABORATORIES**

and Creative Industries Fund NL, Rotterdam

**creative
industries
fund NL**

Made in collaboration with: XPO Gallery, Paris



XPO GALLERY

This work is licensed under the Creative Commons Attribution-NonCommercial-ShareAlike 3.0 Unported License.

To view a copy of this license, visit

<http://creativecommons.org/licenses/by-nc-sa/3.0/> or send a letter to Creative Commons, 171 Second Street, Suite 300, San Francisco, California, 94105, USA.

This book has been printed in a special edition of 200 copies for the "F.A.T. GOLD Europe" exhibition at MU, Eindhoven.

It's also available for free download at

<http://editions.linkartcenter.eu>, and in print-on-demand on Lulu.com and Amazon.com.

The print-on-demand version is:

Printed and distributed by: Lulu.com

www.lulu.com

ISBN 978-1-291-57791-4

INDEX

- 7 **F.A.T. Lab**
- 8 **The F.A.T. Manual** essay, domenico quaranta
- 13 **F.A.T.: It's Not Because They Don't Take Themselves Seriously That You Shouldn't**
essay, régine debatty
- 15 **Evan Roth** fellow page
- 16 **Artist Hacker: From Free Software to Fine Art** essay, evan roth
- 20 **James Powderly** fellow page
- 21 **Internet Famous** project, evan roth, james powderly, jamie wilkinson
- 24 **Jamie Wilkinson** fellow page
- 25 **Hip-Hop Pop-Ups** project, evan roth
- 26 **Tobias Leingruber** fellow page
- 27 **FFFFFire FFFFox** project, evan roth
- 28 **Theo Watson** fellow page
- 29 **Tourettes Machine** project, theo watson
- 31 **The Power Point Album** project, F.A.T. Lab
- 32 **Public Domain Donor** project, evan roth
- 33 **#BADA55 in a Can** project, evan roth
- 34 **Rolltube. The Rick Roll Firefox Extension**
project, theo watson
- 38 **Becky Stern** fellow page
- 39 **F@T Patches** project, becky stern
- 40 **Laptop Compubody Sock** project, becky stern
- 41 **Bennett Williamson** fellow page
- 42 **Office Party Screensaver** project, bennett williamson
- 43 **Greg Leuch** fellow page
- 44 **FuckFlickr** project, jamie wilkinson, greg leuch, theo watson
- 45 **Lilipad Arduino Embroidery** project, becky stern
- 46 **Randy Sarafan** fellow page
- 47 **The Breathalyzer Microphone** project, randy sarafan
- 48 **Kung-Fu Talking Jesus and Bald Baby Buddha Buddy** project, randy sarafan

- 49 **Aram Bartholl** fellow page
- 50 **China Channel Firefox Add-On**
project, tobias leingruber, aram bartholl, evan roth
- 52 **TV-B-Gone Hoodie** project, becky stern
- 53 **Double Keyboard** project, evan roth
- 54 **Low Tech Rick Roll** project, tobias leingruber
- 55 **Pirates of the Amazon** project, tobias leingruber
- 57 **Steve Lambert** fellow page
- 58 **Impressionist Me, Now Me** project, steve lambert
- 60 **How to Make Permanent Asphalt Mosaics
with Linoleum** project, becky stern
- 61 **The Joydick** project, randy sarafan, noah weinstein
- 63 **Geraldine Juárez** fellow page
- 64 **Kopyfamo'** project, geraldine Juárez
- 65 **SelfControl** project, steve lambert
- 66 **LilyPad Arduino Blinking Bike Safety
Patch** project, becky stern
- 67 **KANYE WEBST WEEK** project, F.A.T. Lab
- 68 **KANYE VISION BOOKMARKLET**
project, tobias leingruber, evan roth
- 69 **KANYEFY BOOKMARKLET** project, greg leuch, evan roth
- 71 **Ctrl+F'd** project, greg leuch
- 72 **Speed Project** project, aram bartholl
- 73 **Fuck 3D** project, aram bartholl
- 74 **Chris Sugrue** fellow page
- 75 **EyeWriter** project, F.A.T. Lab
- 77 **MumbaiWriter** project, james powderly
- 78 **LiveWriter** project, theo watson
- 79 **Golan Levin** fellow page
- 80 **GML - Graffiti Markup Language** project, F.A.T. Lab
- 82 **FatTag Deluxe** project, theo watson, KATSU
- 83 **#000000book.com** project, jamie wilkinson, evan roth, theo watson,
chris sugrue, todd vanderlin
- 84 **Robotagger** project, golan levin
- 86 **GML v1.0 Spec Doc** project, golan levin, evan roth, jérôme saint-clair,
chris sugrue, jamie wilkinson, theo watson
- 90 **GML Recording Machine** project, muharrem yildirim
- 91 **FAT Hoodies** project, becky stern

- 92 **Lost and Found** essay, geraldine Juárez, randy sarafan
- 98 **Fuck Google** project, F.A.T. Lab
- 100 **Are You Evil?** project, aram bartholl
- 101 **Fuck Google Pins** project, geraldine Juárez
- 102 **Fuck Picasa** project, geraldine Juárez
- 103 **fuckCAPTCHA** project, greg leuch
- 104 **Dr. Google** project, greg leuch
- 105 **The Fake Google Street View Car** project, F.A.T. Lab
- 110 **Gcar Tracker** project, greg leuch
- 111 **Google Alarm** project, jamie wilkinson
- 112 **How to Tweet Porn** project, randy sarafan
- 115 **Auto Smiley** project, theo watson
- 116 **Twitter Fileshare** project, greg leuch, theo watson
- 117 **Catch a Cockerfly** project, randy sarafan
- 120 **Shaved Bieber** project, greg leuch
- 123 **LM4K** fellow page
- 124 **FFFFFAT Turntables** project, LM4K
- 125 **The Clap-Off Bra** project, randy sarafan
- 126 **Kyle McDonald** fellow page
- 127 **Happy Things** project, kyle mcdonald
- 128 **Ai Weiwei FUCK OFF Bookmarklet** project, aram bartholl
- 129 **Free Ai Weiwei Glasses** project, aram bartholl
- 130 **Infoviz Graffiti** project, golan levin
- 132 **People Staring at Computers** project, kyle mcdonald
- 134 **Media Artist Contingency Plan** project, randy sarafan
- 135 **QR_STENCILER and QR_HOBO_CODES** project, golan levin
- 139 **Digital Purchase Takedown Notice** project, greg leuch
- 140 **Show Me Videos Non-Stop** project, jamie wilkinson
- 141 **Dead Drop Installed at Abandoned U.S. Spy Station** project, tobias leingruber
- 142 **The Googler** project, randy sarafan
- 146 **Christopher “moot” Poole** fellow page
- 147 **Occupy the Internet** project, F.A.T. Lab
- 149 **Occu(pi) Bot** project, randy sarafan
- 152 **Scratch Markup Language** project, jamie wilkinson, kyle mcdonald, LM4K

- 153 **Scratch Markup Language Fader Hack** project, LM4K
- 155 **Noisy Typer** project, theo watson
- 156 **Social ID Bureau** project, tobias leingruber
- 158 **The Free Universal Construction Kit** project, F.A.T. Lab
- 168 **subpixel** project, F.A.T. Lab
- 169 **Enforce!** project, geraldine Juárez
- 171 **Addie Wagenknecht** fellow page
- 172 **BRICKiPhone** project, addie wagenknecht
- 173 **The Optimization of Parenthood** project, addie wagenknecht
- 174 **Limited Editions of Unlimited** project, addie wagenknecht
- 175 **F.A.T 3D Swag** project, geraldine Juárez
- 176 **HOW TO: Licenses Your Artworkz** project, addie wagenknecht
- 182 **F.A.T NIKA** project, geraldine Juárez
- 183 **Magnus Eriksson** fellow page
- 184 **Hot Line Riot from 1982** project, magnus eriksson
- 193 **J3DILLA** project, geraldine Juárez
- 194 **Fake URL Trolling** project, aram bartholl
- 195 **The Instagram Riots of Gothenburg 2012** project, magnus eriksson
- 198 **KATSU** fellow page
- 199 **KATSU x MINECRAFT** project, KATSU
- 200 **Fuck Google Glass, Apple Eyes Fool!** project, KATSU
- 201 **Webcam Venus** project, addie wagenknecht, pablo garcia
- 204 **Hello Bitcoin** project, geraldine Juárez
- 205 **F.A.T. GOLD** project, F.A.T. Lab
- 207 **Your Art!!!** project, aram bartholl
- 208 **F.A.T. Public Access** project, bennett williamson, jamie wilkinson
- 211 **Ideas Worth Spreading** project, evan roth
- 212 **Google Self-Driving Car** project, F.A.T. Lab
- 214 **Status Update** project, KATSU
- 215 **Social Roulette** project, kyle mcdonald
- 220 **Obama Google Glass Prism Mask** project, aram bartholl
- 221 **Treddy** project, golan levin

F.A.T. Lab is an organization dedicated to enriching the public domain through the research and development of creative technologies and media. F.A.T. Lab's greater network of artists, engineers, scientists, lawyers, and musicians are committed to supporting open values and the public domain through the use of emerging open licenses, support for open entrepreneurship, and the admonishment of secrecy, copyright monopolies, and patents.

F.A.T. Lab was co-founded in 2007 by Eyebeam senior fellows Evan Roth and James Powderly. Over the past five years, the group has grown to include twenty-five artists, designers and hacker from 3 continents. F.A.T. Lab members include: Mike Baca, Aram Bartholl, Magnus Eriksson, Geraldine Juárez, Michael Frumin, KATSU, Steve Lambert, Tobias Leingruber, Zach Lieberman, Greg Leuch, Golan Levin, Kyle McDonald, Jonah Peretti, Christopher "moot" Poole, James Powderly, Evan Roth, Borna Sammak, Randy Sarafan, Becky Stern, Chris Sugrue, Addie Wagenknecht, Theo Watson, LM4K, Jamie Wilkinson, Bennett Williamson, and Hennessy Youngman.

<http://fffff.at/>

The F.A.T. Manual

by Domenico Quaranta

<http://www.linkartcenter.eu>

“[...] works of art exist simultaneously in two “economies,” a market economy and a gift economy. Only one of these is essential, however: a work of art can survive without the market, but where there is no gift there is no art.”

— LEWIS HYDE [1]

Artists don't usually share their methods, strategies and practices. As in all markets, originality and the development of a “signature style” – whatever that entails – is everything in the art world. Commonly, an artist's career consists in attending an art school; learning a very specific, self-referential set of practices and ideas until she masters them; identifying what has never been done in that particular field; doing it; trying to get it accepted by the art world; repeating it for the rest of her life. This not only has dangerous consequences for her own work, but for art in general. Secrecy prevents innovation; sharing fosters it – which is one of the reasons why today's contemporary art is so stagnant and boring. The combined effect of a limited set of tools, secrecy about how they are used, and repetition as a response to the market's demand for a personal style can only lead to stagnation. Innovation in art petered out at some point in the twentieth century, and all the hype – “fresh!”, “young!” “exciting!” – that contemporary art's marketing department keeps churning out cannot hide the simple truth: the emperor is naked.

The Free Art and Technology Lab (F.A.T. Lab) takes the opposite approach. Looking at the way other communities – activists, hackers, DIY designers and researchers – work, and appropriating their methods, languages and instruments, F.A.T. Lab expands the set of tools available to contemporary artists. Embracing the ethics of free culture, F.A.T. Lab shares everything it does, making its work available under open licenses for everybody to appropriate, manipulate, study, develop derivative projects from and release those in the same way. “Enriching the public domain through the research and development of creative technologies and media” is its mission statement. By working on collaborative projects, publishing them online on the F.A.T. Lab website and releasing their source code, F.A.T. Lab challenges the romantic myth of the artist as a solitary genius devoted to developing an individual language that belongs to her alone.

F.A.T. Lab is not, of course, alone in this process. Both before and since F.A.T. Lab came into existence there have been artists working

The F.A.T. Manual

with a similar approach. F.A.T. fellows apply this rationale both individually, and as part of other groups. F.A.T. Lab, however, is committed to pursuing it constantly, openly, rapidly and informally. To paraphrase Evan Roth, F.A.T. Lab is the unsolicited guerrilla marketing division for the open source revolution in art.

The F.A.T. Manual is the “how to” of this revolution. Humble as a tutorial, ambitious as a manifesto, it is the “Little Red Book” of those who think that information wants to be free, that everybody should have access to its tools, and that art is not a separate, self-referential world or a hoard of luxury objects gathering dust in private collections and museums, but a field of practice that is in constant dialogue and exchange with other fields, and a game that everybody can enjoy, and everybody can take part in. *The F.A.T. Manual* is not a catalogue, but a tool. It is released under the Creative Commons Attribution-NonCommercial-ShareAlike 3.0 Unported License, and anybody caught usin’ it without our permission, will be mighty good friends of ourn, cause we don’t give a dern. Download it. Print it. Upload it. Use it. Abuse it. Swing to it. Yodel it. We made it, that’s all we wanted to do. [2]

How to Make Your Own

1. Go to <http://ffff.at/>
2. Select the “Projects” category in the top menu
3. Copy the projects you like (CTRL + C)
4. Paste them into your favorite text editor (CTRL + V)
5. Add some design if you like
6. Save the file
7. Upload it to the internet
8. [Optional] Upload it to your favorite print on demand service, follow the instructions and publish it.

Additional Note by the Author

This short text was (ironically) written in the self-celebratory way in which a F.A.T. project is usually launched and promoted on the F.A.T. website, which is in turn (ironically) inspired by the way new products and solutions are usually launched onto the market. That doesn’t mean I don’t believe in every single word I have written. Even the “how to” above isn’t that far from how things actually happened. I contacted F.A.T. Lab in December 2012, asking if they might be interested in

The F.A.T. Manual

producing a book about their work. They were. I explained that I was not interested in producing a catalogue, or a book of essays and interviews celebrating five (amazing) years of work; rather, I was interested in the way they shared their practices and tools on their website, and felt it might be meaningful to put these on paper. They agreed.

At that point, most of it was done. What followed was just basic editorial work: select the projects, copy the text, put them in chronological order, do some editing when needed, collect hi-res images, design the book. This was possible because everything was already there, available on or linked from their website: descriptions, tutorials, source codes, documentation material. This may seem prosaic, but it isn't. Again: you are missing the point if you think F.A.T. Lab are just the creators of some amusing Firefox add-ons, or the perpetrators of some spectacular media stunts like the *Fake Google Street View Car*, *Occupy the Internet* or *Social Roulette*.

The most important thing about F.A.T. Lab, in my opinion, is that everything they have done so far, even the simplest, most banal and obvious project, is there to be taken, improved on and re-distributed. Sharing is such an important part of their practice that if you remove or simply forget about it, you will miss what really matters in their work. On one level, *The F.A.T. Manual* simply re-enacts the gift economy approach to art in editorial form. This might seem superfluous, but I don't think it is. Even though everything could not be translated into book form, and even though the book still relies on a lot of online resources, available on Github or Instructables, this publication still works as an alternative means of distributing, archiving and offering access to a rich set of resources; an alternative to the Internet, capable of reaching the same goal in a different way. A book is a material object, something you can keep in your pocket and consult when you are offline too. It arranges the content in a linear way, inviting the reader to go through it from start to finish. E-books do not substantially differ. When this publication was still an incomplete pdf draft, a friend told me that before seeing the book she didn't realize F.A.T. Lab did so many interesting projects. And I didn't realize it myself either, until I produced the book, for one simple reason: even if we could do so, we rarely go through an online archive the way we go through a book. We can subscribe to its updates. We can visit it frequently, at different times, for different reasons, via different links, but it's difficult to get an idea of it as a whole.

The F.A.T. Manual

Furthermore, and more obviously, a book brings the contents of a blog to audiences that may not find it online, and stores them in a way that may be more or less permanent, or permanent in a different way. In other words: if what you want to do is share and save, a book can be an extraordinary add-on to an online platform.

The other reasons behind *The F.A.T. Manual* are less of a practical nature, and more conceptually grounded. Throughout the history of art and culture, notation has always been a powerful means to preserve art. Before recordings, music was saved on paper. Even today, music scores might be the safest way to preserve music. Software works in the same way: even if your program is broken, or no longer functions on current hardware, an interpreter given the code might be able to restore it. And since most of the F.A.T. Lab projects are open source software projects, we believe that putting their code (together with additional documentation) on paper might be another way to save them. Moreover, throughout the twentieth century, various bold, radical artists translated their works into scores, instructions, and tutorials – a dematerialized, conceptual form of their art that stressed the importance of concept over execution, avoided commercialization, cast the viewer in an active role, interpreting and contributing to each piece, and kept the works as open and free as possible. The Fluxus scores, or Sol LeWitt's *Wall Drawings* spring to mind. This book is also an attempt to situate F.A.T. Lab in this tradition, by presenting the projects as they were originally released: in the form of instructions. Last but not least, the “user manual” form is chosen as a tribute to the first commandment of the digital age, the approach that F.A.T. Lab deploys so well: “access to tools”. This short yet effective phrase was the subtitle of a revolutionary publication launched in late 1968 with the goal of making a variety of knowledge and tools accessible to all: the *Whole Earth Catalog*. As the name suggests, the *WEC* was not a manual, but a catalog, mainly featuring reviews of books and products that aimed to be “useful as a tool, relevant to independent education, high quality or low cost, easily available by mail.” Although perhaps not all the contents of this book fit this description, they are underpinned by the same approach to cultural production. Of course, not all the projects featured here are presented in tutorial form, or accompanied by their source code. In some cases, that wouldn't even make sense. Some projects are presented as fragments of ongoing research, others are simply described or documented.

The F.A.T. Manual

But those are there to be used, too. They are samples of resistance strategies, experiments of participation in popular culture. Whoever you are, whatever you are doing in your life, you might find them useful, and use them; or you might find them funny, and smile. Hopefully, you'll LOL.

This book is published on occasion of the first European presentation of the *F.A.T. GOLD* exhibition at MU, Eindhoven. Curated by Lindsay Howard and first produced by Eyebeam, New York (April 1 – 20, 2013) *F.A.T. GOLD* was one of the things that made me think that it was time to work on a F.A.T. book. Thanks to Lindsay, it was also what prompted us to speed up the project and release the book for the presentation at MU.

I would also like to thank Angelique Spaninks and MU for their generous support, and all the people who had a hand in making this project possible: Geraldine Juárez, for her amazing help in keeping the ball rolling, selecting the projects, editing the book and discussing it with F.A.T. fellows; Fabio Paris, for his patience and this great design; Philippe Riss and XPO Gallery, for their support and for spreading the F.A.T. word into the art world; Régine Debatty, not just for her beautiful text; and F.A.T., and FAT, and fffff.at...

Brescia, September 15, 2013

Notes

- [1] Lewis Hyde, *The Gift. Creativity and the Artist in the Modern World*, Random House – Vintage Books, New York 1983 (2007), p. xvi.
- [2] To quote Woody Guthrie: "This song is Copyrighted in U.S., under Seal of Copyright #154085, for a period of 28 years, and anybody caught singin' it without our permission, will be mighty good friends of ourn, cause we don't give a dern. Publish it. Write it. Sing it. Swing to it. Yodel it. We wrote it, that's all we wanted to do."

F.A.T.: It's Not Because They Don't Take Themselves Seriously That You Shouldn't

Régine Debatty

<http://we-make-money-not-art.com/>

I didn't see this one coming. I knew the work of several of F.A.T.'s members of course. Some I've been following ever since I started blogging (that was in 2004 since you're not asking). Some appeared on my radar more recently. And I did read with interest of F.A.T.'s projects. I laughed at the Google Street View car stunt and was moved by the generosity of the EyeWriter. But this book took me by surprise. I'm suddenly realizing that F.A.T. have accumulated awards, bright members, an impressive body of works and now they even have a touring exhibition and a printed publication.

One of the characteristics that makes F.A.T.'s work so invaluable is that everyone can get what they are doing. It is funny, it is direct and it is witty. The browser plug-in that erases Justin Bieber from the internet, the super duper easy Fuck 3D glasses, the breathalyzer microphone, the fake TED talks. You don't need to be an art expert nor a cultural critic to respond to their work.

The other thing that makes F.A.T.'s projects worth far more than their weight in gold and Kanye West sneakers is that their pranks and antics come with a conscience. Take FuckFlickr, for example. It might have a bellicose title and the impudent objective to become your go-to, open-source alternative to the famous photo sharing site but its catalyst deserves far more than a snigger. A few years ago, Reporters Without Borders revealed that Yahoo (which acquired Flickr in 2005) had not only been collaborating with the Chinese regime in questions of censorship but that they also provided the police with information that led to the imprisonment of a journalist for "divulging state secrets". So, yeah! fuck Flickr and the internet corporation slash informant behind it. And bless F.A.T. for giving reporter Shi Tao more than a brief headline in your newspapers.

Because that's probably what F.A.T. does best: they hop fast and furious on a new law, trend, piece of news or idea that deserves to be discussed (or mocked) beyond the homogenized discourse of mainstream media. Whether it's a new gadget that puts free speech at risk or an online 'service' which reminds us that all isn't well and free in the land of the Internet. They dissect and turn the revolting, the worrying or the simply irritating into a device, a D.I.Y. tutorial, a free piece of software, a performance or a GIF army for websites that will get the attention of the art curator, the HuffPost writer or simply (and perhaps more importantly) of the web user in need of an easy distraction.

F.A.T.: It's Not Because They Don't Take Themselves Seriously That You Shouldn't

With their in-your-face projects, provocative titles and garish early '90s aesthetic, F.A.T. take no prisoner. They use the tools and icons of our time and embrace pop culture as much as they lambaste it. Their homepage is headed by the likes of Pussy Riot, Kim Dotcom, Rick Astley and Edward Snowden. In no particular order. And because they don't impose any hierarchy on the influence of these contemporary icons of the Internet, F.A.T. manage to reach the people who otherwise do not realize nor care about the issues that the artistic organization cares about. Their call for vigilance might look harmless and gimmicky but it is loud and sneakily powerful (rumor has it that the manifesto for the "Fuck Google" week they wrote for the Transmediale catalogue even made it to a board meeting of Google Germany). [1]

So don't do like I did: don't dismiss F.A.T. just because they make you laugh.

Notes

[1] Cf. www.gratefulgrapefruit.com/interview/evan-roth/.

EVAN ROTH RESEARCH DIRECTOR

Born in USA, 1978

Evan Roth is an American artist based in Paris whose work explores the relationship between misuse and empowerment. Creating prints, sculptures, videos and websites, the work is defined less by medium and genre than by its appropriation of popular culture. Roth's work is informed by the misuse of seemingly rigid structures and the effect that philosophies from hacker communities can have when applied to non-digital systems.

Roth's work is in the permanent collection of the Museum of Modern Art NYC and has been exhibited at various institutions, including the Centre Pompidou, the Kunsthalle Wien, the Tate and the front page of Youtube. He has received numerous awards, including the Golden Nica from Prix Ars Electronica, Rhizome/The New Museum commissions and the Smithsonian's Cooper-Hewitt National Design Award.

Roth is also co-founder of the Graffiti Research Lab and the Free Art & Technology Lab (F.A.T. Lab). To find Roth's work online, just google "bad ass mother fucker".

Evan is represented by N2 Galeria in Barcelona, and XPO Gallery in Paris.

www.evan-roth.com

Artist Hacker: From Free Software to Fine Art

Evan Roth [1]

<http://www.evan-roth.com>

While there are many definitions and uses for the term “hack”, I like to think of it as a clever (often playful) small intervention into an existing larger system. Like the judo fighter using his opponent’s weight to his own advantage, a hack alters a system’s intended purpose and turns it into something new. In this sense, it can be applied to many things outside the world of software development.

When I look at the most interesting artistic developments within my lifetime, I see hacks. In the 1970s, DJs hacked record players and gave birth to sampling, hip-hop and remix. Graffiti writers hacked the subway system to move art around New York City (and later the world). Richard Stallman hacked copyright, releasing a virus (the General Public License) [2] intended to free code as it propagates. The genius of a true hack is often judged not only on its effect, but also on the seeming ease with which it was implemented. Spray paint on a wall, scratching a record, and copyleft are all “too lazy to fail” [3].

In speaking about Linus Torvalds, the creator of Linux, Eric S. Raymond describes his brilliance as the ability “for finding the minimum-effort path from point A to point B” and for being “lazy like a fox”. [4]

Torvalds’ main contribution to Linux was arguably not in programming but in deftly stoking the flames of collaboration. “Release early, release often” [5] was a new and controversial idea in the early 1990s, when the software development model at the time strove for perfect and finalized products. Instead, Torvalds and the GNU/Linux community experimented with publishing software updates multiple times per day. Under this new model, the knowledge-sharing and collaborative production of thousands of anonymous users produced one of the most complicated systems of our age: an operating system.

Today, the majority of servers that power the Internet are running on software not built by corporations or governments, but built for free by a group of passionate and idealistic individuals. [6] Beyond its technical merits, GNU/Linux is also an inspiring example of the power of the networked masses.

For a growing number of artists, the production philosophy developed by the free software movement serves as an exciting alternative to the traditional notion of the artist as a solitary genius and the art object as polished and bug-free. Torvalds believed more frequent releases would create a tighter relationship between the developers (artists) and users (audience), resulting in better software (art).

Artist Hacker: From Free Software to Fine Art

The free software and arts communities are both filled with interesting people motivated not just by money but by the act of creation and a drive to make meaningful, or at least functional, contributions to society. And while few artists have contributed or even read a single line of GNU/Linux source code, there are many that incorporate aspects of its development model into their practice.

For this new generation of artists, where the Internet is an additional platform to exhibit work, and code is an additional medium to create, this notion of the art making process as something fluid and ongoing feels very natural. Artists can now cultivate their own audiences online through a daily stream of creative content via social media, blogs, microblogs, and photo and video sharing sites. Viewers are provided with a closer look at the creative process and can witness a body of work as it develops over time and transforms from idea to creation.

In 2007, inspired in part by open source communities and the hacker mentality, I cofounded the Free Art & Technology Lab (F.A.T. Lab) as a collaborative online space dedicated to open source, art and popular culture. Publicly, the mission was to expand the overlap between free culture and popular culture; privately, it was an opportunity to gently poke friends, collaborators, mentors and personally influential artists into hitting the publish button more often. The motto “release early, often and with rap music” [7] is as much a reference to our public mission statement as it is a subtle cue to F.A.T. Lab members of the informal nature of publication. As informality goes up, so does the rate of publication, since F.A.T. Lab was intended to be a place where people could publish projects that they might not have necessarily posted otherwise.

This group is comprised of roughly twenty people with interests that include fine arts, graffiti, hip-hop, activism, free speech, DIY, net art, Internet memes, web startups and colors represented by hexadecimal values. We have a yearly operating budget of 100 euros, which is spent on Internet hosting and a “.at” domain name registration. We have no meetings, no rules, no hierarchy and everyone has all the passwords to everything. F.A.T. Lab is an experiment in a friendly collaboration based on respectful anarchy. If the free culture movement is a car with GNU/Linux as the engine, then F.A.T. Lab is the rims that keep spinning when the car comes to a

Artist Hacker: From Free Software to Fine Art

stop. Our role is not to make the engine run smoother, but to make the kids more interested in driving it to the club. We are the unsolicited guerrilla marketing division for open source, and we are attempting to interject more fun into art and activism. If you rush the hair out of Justin Bieber's eyes, or look closely through the slits of Kanye's shades, we hope you will see nuggets of something more substantial than the #FF00FF and #FFF000 [8] candy coating [9] that glosses the outside of many F.A.T. projects. At the center of the F.A.T. lollipop is a genuine interest in expanding the sphere of influence surrounding free culture and inserting open ideals into mainstream popular culture.

Despite the connection to technology, I do not see members of F.A.T. or other artist hackers cleanly fitting into either the "new media art" or "net art" genres. We identify more with the hack than with the code, and our interests in making work online are in large part due to the impressive ratio of production costs to cultural influence. The most exciting thing about the Internet is not specific to any visual aesthetic or programming language, but relates to the vast number of people it allows us to freely reach. The Internet has allowed more and more individuals to become makers, participants and viewers of art and presents artists with the opportunity to speak to the equivalent of a packed football stadium on a daily basis. Artists have never had such a large and immediate influence on culture, and it would seem a missed opportunity not to recognize, welcome and engage this new online audience. This is not to say that art should be reduced to the level of LOLcats and evaluated based on view counts and "likes". Rather, I think the challenge to make art that communicates with critics, curators and the "bored at work network" [10] is a new and culturally relevant practice.

Notes

- [1] This text has been adapted from an earlier version by the author that appeared in *Aram Bartholl: The Speed Book* (edited by D. Quaranta, Gestalten, Berlin 2012). It was published in this form in the *New York Magazine of Contemporary Art and Theory*, Issue 06 (edited by Mariana Aguirre and Paulina Ascencio) and is available online at the URL http://ny-magazine.org/PDF/06.02.EN_Artist_Hacker.pdf.
- [2] General Public License (www.gnu.org/licenses/gpl-3.0.txt).
- [3] The phrase "too lazy to fail" and the notion of "constructive laziness" come from the 1973 book *Time Enough for Love*, by Robert A. Heinlein.
- [4] Eric S. Raymond, *The Cathedral and the Bazaar*, 1999. Available online at the URL <http://catb.org/~esr/writings/cathedral-bazaar/cathedral-bazaar/ar01s03.html>.
- [5] Ibid.

Artist Hacker: From Free Software to Fine Art

- [6] A 2009 survey of 38,549,333 servers reported the Apache/Linux market share at 72.09% (cf. https://secure1.securityspace.com/s_survey/data/200907/index.html).
- [7] Taken from the chapter title, “Release Early, Release Often” in Eric S. Raymond’s *The Cathedral and the Bazaar*.
- [8] The hexadecimal representation of pink and yellow.
- [9] From Michelle Kasprzak’s introduction at Transmediale, Berlin, 2010. “You shouldn’t let their candy coated shell bright colors and flash style distract you from their very serious mission of disseminating open source culture and all manner of pop culture pranksterism.”
- [10] The “bored at work network” is a term developed by Jonah Peretti to describe an online audience potentially larger than many mainstream media outlets.
Cf. www.stayfreemagazine.org/archives/25/jonah-peretti-interview.html.
- [11] Cf. Richard M. Stallman, *Free Software Free Society: Selected Essays*, 2002.
Available online at the URL www.gnu.org/philosophy/fsfs/rms-essays.pdf.

JAMES POWDERLY RESEARCH DIRECTOR

James Powderly was born in Chattanooga, Tennessee in 1976. He has been making technology and media at the fringes of robotics, graffiti, space science, tattoos and rock n roll since 1992.

James was a Senior Research Fellow in the Eyebeam R&D OpenLab developing creative tools and media to directly enrich the public domain. Prior to working at Eyebeam, he was an engineer at Honeybee Robotics, a Manhattan-based NASA contractor. He was a part of the team that developed and operated the Mars Exploration Rover's Rock Abrasion Tool and built a 4-meter robot for Diller+Scofidio's retrospective at the Whitney Museum of American Art.

James has been awarded grants, fellowships, detentions and commissions for his own work, including an Award of Distinction in 2006 from Ars Electronica for co-founding the Graffiti Research Lab. His work is in the permanent collection of the Museum of Modern Art in New York City and the permanent collection of robotic debris on the planet Mars, but you can find it year-round on the web and on other people's property all over the world.

James has worked as an adjunct faculty member in the Communication Design and Technology Department at Parsons since 2007. He lives in Berlin, Germany.

<http://graffitiresearchlab.com/>

Internet Famous

by James Powderly, Evan Roth and Jamie Wilkinson

2007 – 2008

<http://internetfamo.us>

Internet Famous was a class given by James Powderly, Evan Roth and Jamie Wilkinson in Parsons graduate Design & Technology program, and dedicated to learning how to spread your work to the widest possible audience online. It was also the first algorithmically graded class in the history of academics: the lecturers developed a software called Famotron, that measured the online attention economy – view counts, blog links, social media activity, followers and their influence – and awarded students their final letter grade. The class run for two years (2007 and 2008), but the website was sporadically updated until early 2009. Browsing it, you can still find traces of case studies proposed to students, student projects, short essays and comments. The following is the official presentation texts available in the About page of the website.

“Fame is proof that the people are gullible.”

— RALPH WALDO EMERSON

Just because a lot of people see your stuff doesn't mean it's good... but it does mean you're famous – *Internet Famous*. This course is dedicated to learning how to spread your work to the widest possible audience online. We study the art and science of getting hits. And in an academic first, students' grades will be awarded by a piece of software that helps students track their websites & online accounts and monitor their popularity in real-time.

Sites like Digg, del.icio.us, YouTube, Flickr, Facebook, Technorati, Alexa, Google, LinkedIn, Twitter and many more will be mined for data relevant to the amount of attention a student is receiving, such as view counts, friend counts, inbound blog links, the length and intelligence level of comments, and more. This raw data is calculated into a “Famo Index Score” that will be mapped onto the Parsons Graduate Grade Scale Description, and each student given a grade from an A to an F.

Students create their own projects, independently or in small groups, using any media in conjunction with the Internet. This is a no-holds-barred exercise in hit seeking, and experimentation is strongly encouraged.

Through the course of the class we'll study successful contagious media projects, learn tools for improving and tracking your performance, explore the history of internet memes, infiltrate online social networks, discuss monetization strategies, and experiment with methods of licensing, marketing and distributing work.

We can't promise that you will attain Internet fame, but we're almost certain this class will make us famous. Good luck.

Internet Famous

Fine Print

Internet Famous meets for one two-hour and forty minute session per week, and at least 10 hours of work per week is expected from each student. As per University policy, 3 absences constitute grounds for failure, but unless they can hack our website, the software will still give you a grade. Two absences will result in an automatic academic warning and a denial of service attack on your server.

Process

Parsons Collaboration Studios are premised on students working together in a creative team. During the course of the semester we will use, hack, game, ridicule and stress-test the Internet, and track our progress & results using the Famotron. We will also collectively build the Internet Famous *Hall of Famo*, a database of popular people, brands, memes, and more, which can help inform our decision making. Students will be able to learn from and provide input into the design of the technologies, algorithms, and concepts behind *Internet Famous*. Enrollment in this class is akin to a research fellowship at the Xerox PARC of the Interwebs, and much of our class time will revolve around discussion and presentation of your own research and experimentation on the web, what we can learn from it, and how we can better measure it. Each student will be required to lead at least one “Profile in Famo” session as their contribution to the *Hall of Famo*. These sessions will consist of each student presenting their own biographical research into a specific Internet celebrity, meme, company, band, or other topic by registering a new Famotron profile, finding their web properties & notable citations, and correlating with notable events in the subject’s career. Examples: create a profile for an Internet mega-star like Tim Berners-Lee or Tay Zonday, a comparison of two things on the web, like Cat famo vs. Dog famo, or even a series of famo profiles for the 2008 Presidential candidates.

Documentation

This class is about spreading your work on the web. Students will be asked to create a number of online accounts on community sites like YouTube, Twitter, and Delicious. Students will also be required to maintain at least one website where they archive the majority of their own projects. A personalized domain name is highly recommended.

The class will include a great deal of discussion on how to make your website easy to find and easy to use, and what tools and techniques to employ to monitor and increase your site’s popularity.

Internet Famous

Assessment and Grading

Internet Famous is the first algorithmically graded class in the history of academics. Evaluations of students work will be done by the FameLab, a web application that quantitatively measures your web popularity. Each student will input their websites, various user accounts, and links to specific press about them and track their fame level throughout the semester. At the time of writing at least the following sites will be mined for data: Digg, del.icio.us, YouTube, Flickr, Technorati, Alexa, Twitter, MySpace, Facebook, Vimeo, Tumblr, Instructables, Compete, Quantcast, Reddit, Yahoo, Google, Wikipedia. From these raw inputs the Famotron will calculate an index score that represents each student's overall Internet fame, or "Famo Score". Our analytical model accounts the inherent difference in the attention value of various metrics, and a robust weighting system allows the software and the class to adapt to changes in available information, technical or social flaws, and other perturbations of the Internets. The instructors will have the final word on all weighting decisions but students are invited to offer input into the process. Ultimately a student's "Famo Score" will be directly mapped onto the Parsons Graduate Grade Scale Description. We will go into great detail describing the algorithm during the first class, and much of the class itself represents an exploration of the derivation of the famo algorithms. Everyone will have a robust understanding of the way this works so that you can best contribute to it, game it, hack it, and otherwise improve and fine-tune it. You will not be graded on your homework, but only completed assignments will be posted on the <internetfamo.us/class> blog and the famo bonus points that provides. In the end, a cold, heartless Turing machine will give you a grade. You – and the rest of the world – will be able to monitor your grade in real-time, with each student represented by a crudely photoshopped bobble head on a bar graph. You are going to be a big part of a grand experiment, and if you follow our advice, work hard, and stay sharp, you will get a good grade. And – who knows? – you might just become *Internet Famous*.

Graduate Grade Scale Descriptions

- A Work of exceptional quality
- A- Work of high quality
- B+ Very good work
- B Good work; satisfies course requirements
- B- Below average
- C+ Less than adequate
- C Well below average; lowest possible passing grade
- F Failure, no credit

JAMIE WILKINSON **Virtual Research Fellow**

Jamie Wilkinson is an Emmy Award-winning software developer & Internet culture researcher. His work focuses around open-source, pop culture and the propagation of information & ideas online. He is currently building VHX.tv <www.vhx.tv>, a video sharing community.

He is co-creator of the *Know Your Meme* video series & Internet meme database <<http://knowyourmeme.com>> selected as one of TIME Magazine's Top 50 websites of 2009, and part of the team behind *Star Wars Uncut* <<http://starwarsuncut.com>>, a crowdsourced recreation of Star Wars that was awarded an Emmy for Interactive Media in 2010.

Wilkinson is also a founding member of the Free Art & Technology F.A.T. Lab. Previously Wilkinson taught the “Internet Famous” class in Parsons graduate design & technology program, in which students' grades depend on how much Internet traffic they can generate. Wilkinson's work has been featured in the *New York Times*, NBC, TIME, CNN, NPR, CurrentTV and on the front page of YouTube. He is a proud contributor to open-source software.

<http://jamiedubs.com>

Hip-Hop Pop-Ups

by **Evan Roth** February 2007

<http://ffff.at/hip-hop-popups/>



Hip-Hop Pop-Ups is an online mp3 player that pops up the websites of Kanye West's favorite brands in real time as he raps them.

Hip-Hop Pop-Ups is a data visualization of the product placement in Kanye's new album, *Graduation*,

and offers a glimpse at a potential trajectory of the current state of main stream rap music.

MAKE YOUR OWN!

Making your own *Hip-Hop Pop-Ups* albums should be fairly easy, and can be done simply by editing 2 .txt files.

Step 1: Download this .zip archive, and extract it:

http://ni9e.com/hiphop_popup/kanye/howto/hhpp_project_folder_nomusic.zip.

Step 2: Dump what ever .mp3 files you want to create pop-ups for in the directory 'assets/mp3'.

Step 3: Open the file 'assets/text/musictext.txt'. Set the var 'howMany' equal to the number of .mp3 files in the 'mp3' directory. Edit the 'song1' - 'songx' vars so that they are the name of the corresponding .mp3 file name. Similarly, edit the 'title' vars to what you want the song to be displayed.

Step 4: Open the file 'assets/text/popuptext.txt'. Set the 'num pops' vars equal to the number of pop-ups there are in each given song. Edit the 'timecodes' array to a comma separated list of values in seconds. These are the time points where you want the pages to pop-up. Edit the 'urls' array to a list of corresponding http links to be popped up at the timecode values.

Step 5: Double click 'hiphop_popups.html' and you should be off and running. Put all the folder contents on a server and share it with the world.

Step 6: Shoot me an email so I can check it out: evan@ni9e.com.

TOBIAS LEINGRUBER
Virtual Research Fellow

Tobias Leingruber is a free communication designer and project manager at the Mozilla Firefox brand team. His personal work, as fellow of the Free Art & Technology Lab, explores the mutual impacts of internet and society. The web belongs to us!

His latest work includes the *Social Network ID Cards* and the *Firefox Flicks 2013* short film contest <<http://firefoxflicks.org/>>.

Tobias' work has been exhibited internationally and covered by the *NY Times*, *Forbes*, *Wired*, *Spiegel*, *ARTE TV* and others.

www.tobi-x.com

FFFFFire FFFFFox

by Evan Roth February 2007

<http://ffff.at/fffffire-fffffox>

The *FFFFFire FFFFFox* extension enables you to represent F.A.T. to the fffffullest by replacing every 'f' with 'ffff'. Help subtly spread the word about fffffat by installing it on every machine you come across..... it's fffffire.

Source code

```
// ==UserScript==
// @name      FFFFFire FFFFFox Plugin
// @namespace  http://www.ffff.at/
// @description Repping FFFFFat to the FFFFFullest
// ==/UserScript==
//
// Made by Evan Roth of http://ffff.at/evan-roth
// Built from Theo Watson's code for Tourettes Machine Extreme
http://www.ffff.at/tourettes-machine

(function() {

function insertAtCursor(myField, myValue) {
    if (myField.selectionStart || myField.selectionStart == '0') {
        var startPos = myField.selectionStart;
        var endPos = myField.selectionEnd;
        myField.value = myField.value.substring(0, startPos)+ myValue+
myField.value.substring(endPos, myField.value.length);
        var newPos = endPos + myValue.length;
        myField.setSelectionRange(newPos, newPos);
    } else {
        myField.value += myValue;
    }
}

var allfieldsInput = document.getElementsByTagName('input');
var allfieldsText  = document.getElementsByTagName('textarea');

for (var i=0; i<allfieldsInput.length; i++){
    var field = allfieldsInput[i];
    if((field.getAttribute('type') == 'text')){
        field.addEventListener('keypress', function(e){if(e.which ==
102)insertAtCursor(this, 'ffff');if(e.which == 70)insertAtCursor(this,
'FFFF');}), false);
    }
}

for(var i=0; i<allfieldsText.length; i++){
    var field = allfieldsText[i];
    field.addEventListener('keypress', function(e){if(e.which ==
102)insertAtCursor(this, 'ffff');if(e.which == 70)insertAtCursor(this,
'FFFF');}), false);
}

})();
();
```

THEO WATSON

Virtual Research Fellow

Theodore Watson is an artist, designer and experimenter whose work is born out of the curiosity and excitement of designing experiences that come alive and invite people to play.

Theodore's work ranges from creating new tools for artistic expression, experimental musical systems, to immersive, interactive environments with full-body interaction.

His recent work includes the *Eyewriter*, an eye controlled drawing tool, *Graffiti Research Lab's Laser Tag*, laser graffiti system and *Funky Forest*, an immersive interactive ecosystem for young children. Theodore works together with Zachary Lieberman and Arturo Castro on *openFrameworks* (<http://openframeworks.cc/>), which is an open source library for writing creative code in C++.

Theodore Watson's work has been shown at MoMA, Tate Modern, Ars Electronica, The Sundance Film Festival, Res Fest, REMF, Cinekid, Montevideo, OFFF, SHIFT, ICHIM, The Creators Series, Deitch Projects, Eyebeam, Pixel Gallery, Museum N8 Amsterdam. In 2010 the *Eyewriter* project won the Future Everything award and the Design of The Year award for the interactive category.

Theodore Watson is founder of two interactive studios, Design I/O LLC and YesYesNo LLC.

<http://theowatson.com>

Tourettes Machine

by **Theo Watson** October 2007

<http://ffff.at/tourettes-machine>

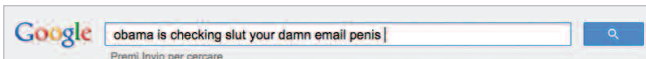
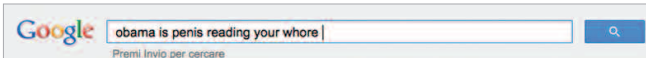
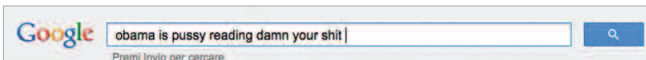

Tourettes Machine is a firefox plugin that randomly adds swear words to your form fields and text areas as you type.

There are two versions of the plugin: moderate and extreme.

The first adds insults every 3-5 words; the “extreme” version adds insults every other damn word bitch.

Editing the source code below, you can add your own words or where make a honkey native language version too.

Source code

```
// ==UserScript==
// @name      Tourettes Machine Extreme
// @namespace  http://www.ffff.at/tourettes-machine
// @description  Helps with shit your spelling
// ==/UserScript==

//
// Originally written by Theodore Watson of http://ffff.at/theo-watson
// Licensed for unlimited modification and redistribution
//
// This is a 'internet art' extension and should not be installed on any
// one else machines
// as it might end up in them getting fired for inappropriate language -
// hehe
// feel free to add your own words into the array bellow.

(function() {
var
badwords=['cunt','dick','dildo','foreskin','honkey','motherfucker','penis',
', 'piss','prick','pussy','slut','smut','twat','wank','whore','bitch','bas
tard','damn','shit','fuck','ass','asshole'];

//set this to some value between 0.0 and 1.0
```

Tourettes Machine

```
//the higher the number the more infrequent the
//swear words
var amnt = 0.45;

function insertAtCursor(myField, myValue) {
  if (myField.selectionStart || myField.selectionStart == '0') {
    var startPos = myField.selectionStart;
    var endPos = myField.selectionEnd;
    myField.value = myField.value.substring(0, startPos)+ myValue+
myField.value.substring(endPos, myField.value.length);
    var newPos = endPos + myValue.length;
    myField.setSelectionRange(newPos, newPos);
  } else {
    myField.value += myValue;
  }
}

function addBadWord(whichElement){

  if(Math.random() > amnt){
    var whichWord = Math.round((badwords.length-
1)*Math.random());
    insertAtCursor(whichElement, ' '+badwords[whichWord]);
  }
}

var allfieldsInput = document.getElementsByTagName('input');
var allfieldsText = document.getElementsByTagName('textarea');

for (var i=0; i<allfieldsInput.length; i++){
  var field = allfieldsInput[i];
  if((field.getAttribute('type') == 'text')){
    field.addEventListener('keypress', function(e){if(e.which ==
32)addBadWord(this;}, false);
  }
}

for(var i=0; i<allfieldsText.length; i++){
  var field = allfieldsText[i];
  field.addEventListener('keypress', function(e){if(e.which ==
32)addBadWord(this;}, false);
}

})
();
```

The Power Point Album

by F.A.T. Lab January 2008

http://fffff.at/ppt_album/

(Allow me to re-introduce myself)



**My Name is HOV.
(H → OV)**

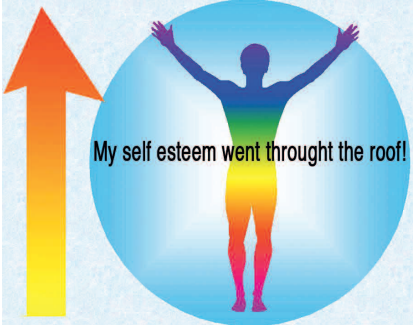

My self esteem went through the roof!

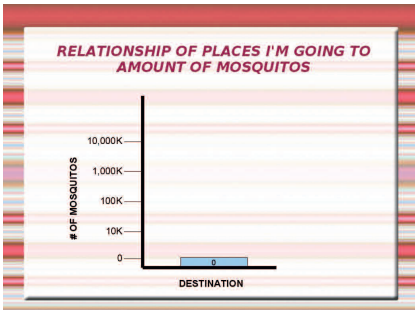

Things To Never Do:

- Go to Jail
- Pay a nigga to do dirt you are scared to do yourself
- Tell
- Run
- Get smacked
- Ask for nothing you don't demand of yourself
- Play yourself
- Sit back feeling sorry for yourself

The *Power Point Album* is a downloadable Power Point presentation of 41 slides, inspired by fragments of lyrics by famous American rapper and producer Shawn Corey Carter aka Jay-Z, and synchronized with the corresponding mp3 samples of the same songs.

When you play the presentation in “autoplay” mode, the samples are remixed in real time, while you look at the corresponding visuals.

The project was inspired by found webpage offering mathematical charts and graphs translating famous rap songs.

Public Domain Donor

by **Evan Roth** February 2008

<http://ffff.at/public-domain-donor/>

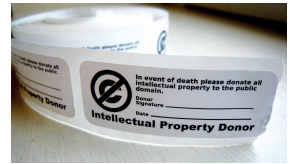
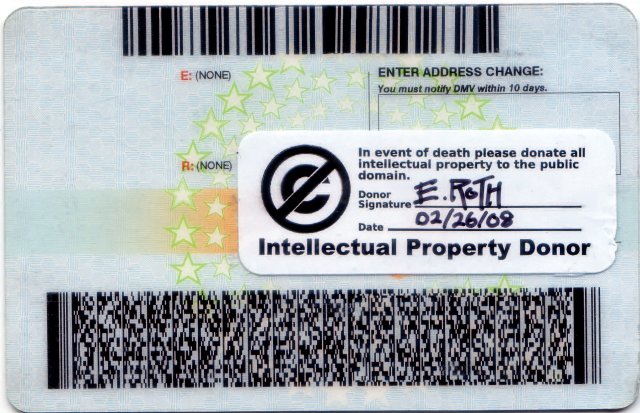
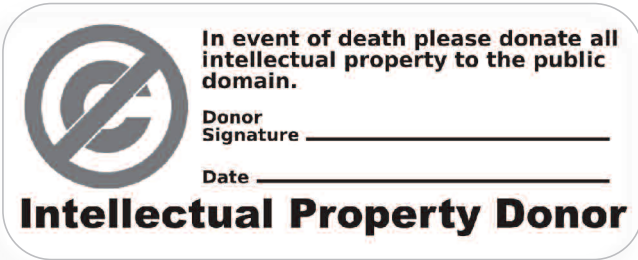

Why let all of your ideas die with you? Current copyright law prevents anyone from building upon your creativity for 70 years after your death. Live on in collaboration with others.

Make an intellectual property donation. By donating your IP into the public domain you will “promote the progress of science and useful arts” (U.S. Constitution).

Ensure that your creativity will live on after you are gone, make a donation today.

#BADA55 In A Can

by **Evan Roth** March 2008

<http://fffff.at/bada55-in-a-can/>

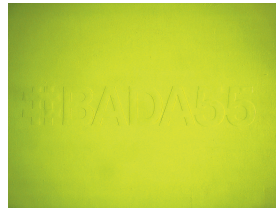

BADA55 is the hexadecimal representation for light green. Thanks to Evan Roth, now you can buy it in a can, or make it following the instructions, and use it to paint canvases or fill markers. Guaranteed to make your art Bad A55!

RollTube - The Rick Roll Firefox Extension

by **Theo Watson** March 2008

<http://ffff.at/rolltube/>

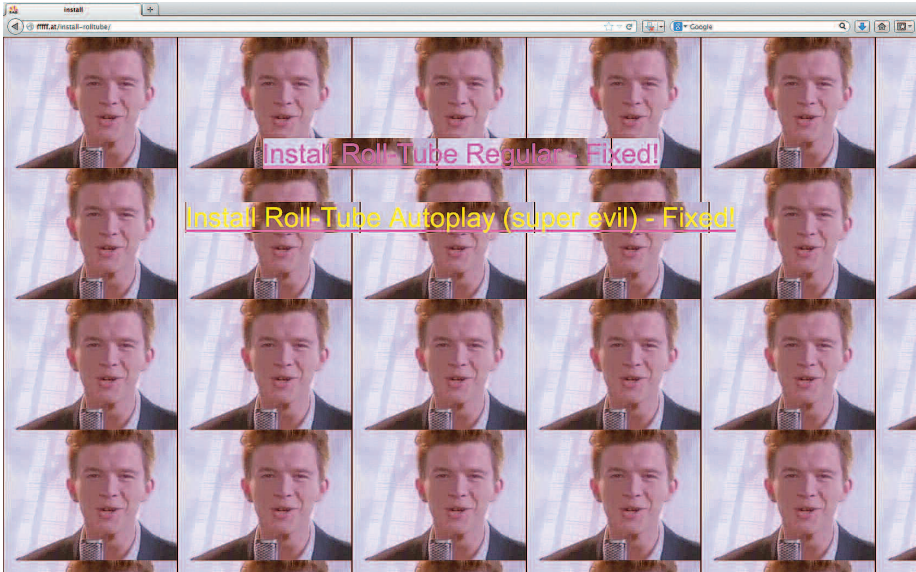

RollTube is a Rick Roll Firefox Extension that switches every YouTube video with the infamous Rick Roll video. [1]
The experience has been described as “like the whole internet ganging up and rick rolling you at the same time”. Great to install across all the machines in your office / lab / classroom. *RollTube* is cross platform and needs no special admin rights to install!

Notes

- [1] According to *Know Your Meme*, “Rickrolling is a bait-and-switch practice that involves providing a web link supposedly relevant to the topic at hand, but actually re-directs the viewer to Rick Astley’s 1987 hit single “Never Gonna Give You Up.” The URL is often masked or obfuscated as a randomly-generated shortlink to conceal its true source from the experienced users. Whenever someone clicks the link and unintentionally summons Rick Astley’s song, he or she is said to have been rickrolled.”
Cf. <http://knowyourmeme.com/memes/rickroll>.

RollTube - The Rick Roll Firefox Extension

Source code

```
// ==UserScript==
// @name      Roll-Tube
// @namespace  http://fffff.at/rickroll-the-firefox-addon
// @description You've been rick rolled!
// ==/UserScript==

//
// Originally written by Theodore Watson of http://fffff.at/theo-watson
// Licensed for unlimited modification and redistribution
//
// This is a 'internet art' extension and should not be installed on any
// one else machines
// as it might end up in them getting fired for inappropriate rick
// rollidge action

(function() {

var autoplay = false;

var id = "gQCOQ63otnk";

if(autoplay){

    id+= "&autoplay=1";
}
var objects = document.getElementsByTagName('object');
for (var i=0; i< objects.length; i++){

    var handle = objects[i].getElementsByTagName("param");

    if(objects[i].getElementsByTagName("param") ){

        var foundVideo = false;
        var w = 425;
        var h = 355;

        var source = handle[0].getAttribute("value");

        if(source.indexOf('youtube.com') != -1){
            foundVideo = true;
            w = objects[i].getAttribute("width");
            h = objects[i].getAttribute("height");
        }

        var dataH;
        if( !foundVideo && ( dataH = objects[i].getAttribute("data") )
        != null ){

            if(dataH.indexOf('youtube.com') != -1){
                foundVideo = true;
                w = objects[i].getAttribute("width");
                h = objects[i].getAttribute("height");
            }
        }
        if( !foundVideo ){

            var embedH =
```

RollTube - The Rick Roll Firefox Extension

```

objects[i].getElementsByTagName("embed");
    if(embedH == null || embedH[0] == null)continue;

    var embSrc = embedH[0].getAttribute("src");
    if( embSrc == null )continue;

    if(embSrc.indexOf('/player2.swf') != -1){
        //alert("YES!");
        foundVideo = true;
        w = embedH[0].getAttribute("width");
        h = embedH[0].getAttribute("height");
    }

}

if( foundVideo ){
    //alert("switching video");
    var newP = document.createElement("object");

    var obj = document.createElement('object');
    obj.id = 'objectID';

    obj.setAttribute('width', w);
    obj.setAttribute('height', h);

    var param = document.createElement('param');
    param.setAttribute('name', 'movie');
    param.setAttribute('value',
'http://www.youtube.com/v/'+id);
    obj.appendChild(param);
    var param = document.createElement('param');
    param.setAttribute('name', 'wmode');
    param.setAttribute('value', 'transparent');
    obj.appendChild(param);

    var embed = document.createElement('embed');
    embed.setAttribute('width', w);
    embed.setAttribute('height', h);
    embed.setAttribute('wmode', 'transparent');
    embed.setAttribute('type', 'application/x-shockwave-
flash');
    embed.setAttribute('src', 'http://www.youtube.com/v/'
+id);
    obj.appendChild(embed);

    objects[i].parentNode.replaceChild(obj,objects[i]);
}
}

//for youtube.com
var embeds = document.getElementsByTagName('embed');
for (var i=0; i< embeds.length; i++){
    //alert("embeds");
    var name = embeds[i].getAttribute("name");
    if(name == "movie_player"){

        //alert("found you tube video");

```

RollTube - The Rick Roll Firefox Extension

```

        var fVars = embeds[i].getAttribute("flashvars");

        if(fVars == null) continue;

        var w = 480;
        var h = 395;

        var obj = document.createElement('object');
        obj.id = 'objectID';

        obj.setAttribute('width', w);
        obj.setAttribute('height', h);

        var param = document.createElement('param');
        param.setAttribute('name', 'movie');
        param.setAttribute('value',
'http://www.youtube.com/v/'+id);
        obj.appendChild(param);

        var param = document.createElement('param');
        param.setAttribute('name', 'wmode');
        param.setAttribute('value', 'transparent');
        obj.appendChild(param);

        var embed = document.createElement('embed');
        embed.setAttribute('width', w);
        embed.setAttribute('height', h);
        embed.setAttribute('wmode', 'transparent');
        embed.setAttribute('type', 'application/x-shockwave-
flash');
        embed.setAttribute('src', 'http://www.youtube.com/v/'
+id);
        obj.appendChild(embed);

        embeds[i].parentNode.replaceChild(obj, embeds[i]);
    }

})
();

```

BECKY STERN
Virtual Research Fellow

Becky Stern is a perennial do-it-yourself-er with over 100 open source project tutorials to her name. She likes microcontrollers, knitting, barcodes, olives, banjos, and the public domain. Stern graduated as valedictorian of her BFA program in Design & Technology at Parsons The New School for Design and dropped out of two different grad programs at Arizona State University.

Becky is director of wearable electronics at Adafruit Industries <www.adafruit.com> and lives in Brooklyn, NY, and on the internet. In addition to F.A.T., she cavorts and makes videos with local badass art combine Madagascar Institute.

<http://sternlab.org>

F@T Patches

by **Becky Stern** March 2008

<http://fffff.at/f-patches/>



A nice way to show off that you belong to a group like F.A.T. or that you support it is adding patches to your clothes, bags and other fags. In order to do it, you may need to reproduce its digital logo(s) in embroidery. Doing it isn't hard if you follow some simple steps.

How to make it

- Step 1: Trace your artwork
- Step 2: Chalk it up
- Step 3: Start embroidering
- Step 4: Create a backing

Full instructions are available on *Instructables*:
www.instructables.com/id/Create-embroidered-patches-from-digital-images/.

Laptop Compubody Sock

by **Becky Stern** April 2008

<http://fffff.at/knitted-compubody-interface/>



Our interactions with personal electronic devices provoke a broad range of emotions from frustration to confusion to feverish obsession. Increasingly, these devices dominate our everyday work activities, our behavior in public space, and our personal communications. *Laptop Compubody Sock* is part of a series of knitted interfaces for electronic devices, that go from gadgets to the user's body. They're a criticism of how engrossed we are in our technological artifacts, even to the point of self-harm; furthermore, they highlight the lack of movement that happens when we're engrossed in our laptops, keyboards, PDAs, etc. The *Laptop Compubody Sock* provides privacy, concentration, warmth, and style, both in private and in public spaces. The series also includes a *Keyboard Interface for Computer Programming*, ideal for skilled programmers that don't need to look at the keyboard, and a *Cell Phone Ski Mask*, that will make your phone calls even longer.

BENNETT WILLIAMSON
Virtual Research Fellow

Bennett Williamson is a graduate of NYU's Gallatin School of Individualized Study with a B.A. in New Media and Arts Production.

Bennett is a founding member of the net art collective *Double Happiness*, whose work has been featured in the *Irish Times*, *MSNBC.com*, and *Wall Street Journal Online*.

He curated and organized *The Great Internet Sleepover* in 2007. He is a member of the Graffiti Research Lab, documenting, shit-talking, video-making, and logging hours as Anti-Hype Man and Official DJ (with the name *Bennett4Senate*). A record collector and DJ, discerning rap aficionado and field recordist, he has hosted radio shows on WNYU and WMBR, and currently on WFMU in Jersey City.

A Gemini, Bennett grew up in Boston and now lays his head in the planet of Brooklyn, where he rides hella bikes and tends his backyard vegetable garden. Bennett enjoys a fast internet connection, a dope mix, animated gifs, fresh slang, productivity, and the piercing "skreeeeee!" of the bald eagle high above as he raises his American flag every morning.

<http://bennettwilliamson.com>

Office Party Screensaver

by **Bennett Williamson** May 2008

<http://ffff.at/mac-screensaver-hack-office-party-screensaver/>

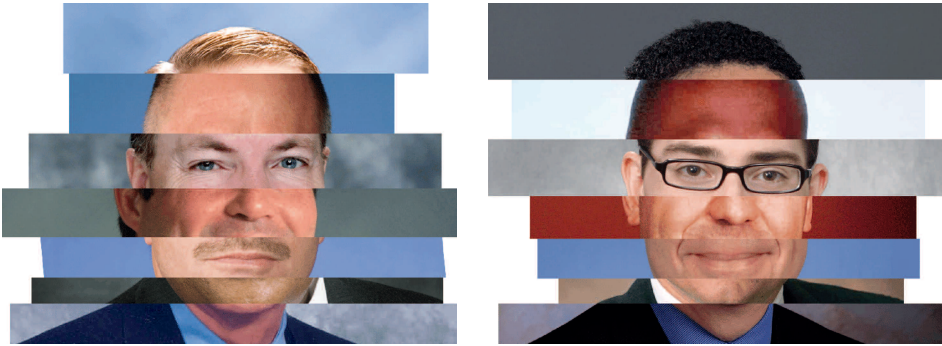

The default Mac OS X (I'm on version 10.4.11) screensaver picture slideshow function can read an alpha channel in a .gif file.

That is to say, as the slideshow plays your images, a .gif with an alpha channel will appear to be "on top" of the previous image, and as the slideshow goes on, the .gifs will continue to "layer" on until an image of a different format is displayed, which has a default white or black background.

So what? Take advantage of the randomizing function to create some home-made screensaver machinima art! Or just download the *NEW Office Party Screensaver* from FATLAB.

This screensaver is a series of carefully-sliced 800×600 .gifs, sourced from the faces of the hardest working local board members, regional vice presidents, administrative assistants, and other fruitful regular-dude-generating search terms on the internet.

The .gifs layer over one another to hybridize these generic gentlemen into a randomly-generated ultimate budget-balancing force of suits.

To install it:

- download a small .zip file of the .gifs:
<http://ffff.at/bennett/FINALgifs.zip>;
- Unzip the folder;
- Point your screensaver to it;
- Go to Screensaver > Preferences, and check "Cross-fade between slides" and "Present slides in random order".

GREG LEUCH
Virtual Research Fellow

Greg Leuch is a creative & user interaction designer with specialty in user interface design, usability, front-end production, and feature development. His work is known for combining Internet technology with pop culture, creating useable products and resources for the Internet masses. Best known for his series of browser content blockers, his work have been internationally featured by NBC, The Guardian, CBC, TIME, ARTINFO, MTV, The Creators Project, and GOOD, and has received numerous Reddit frontpages, high-fives, and death threats for his work in combining pop culture with new media art and technology. His work has been shown at the transmediale Festival (Berlin), Netherlands Media Art Institute, National Museum of Contemporary Art (Athens), Eyebeam (NYC), and Art Micro Patronage (Internet).

Greg is co-founder of XOlator, a New York City-based creative team. He is also a virtual research fellow of the notorious Free Art & Technology Lab (FAT Lab). He has worked previously as a Senior Designer at BuzzFeed and Director of R&D at Know Your Meme / Rocketboom and holds a BFA in Graphic Design from Auburn University.

<http://gleu.ch>

FuckFlickr

by **Jamie Wilkinson, Greg Leuch, Theo Watson** May 2008

<http://fffff.at/fuck-flickr-yahoo-is-a-narc/>



Shi Tao is a Chinese writer and dissident serving a 10-year sentence in prison for writing articles calling for political reform in China. Yahoo helped put him there. [1]

FuckFlickr is an open-source image gallery software that won't narc you out. We created it as an alternative to hosting your photos on a certain Yahoo-owned photo sharing site.

No database is required; just upload it and put images in the data directory.

Installation instructions:

- Download FuckFlickr: <http://fffff.at/download/fuckflickr-2-0.zip>;
- unzip and upload the “fuckflickr” directory to your server;
- put images or folders w/ images into the “data” subdirectory;
- visit yourdomain.com/fuckflickr — the first visit will generate thumbnails!
- Bonus: after the first visit, download and open the `info.yml` file in the gallery's directory. Add titles and descriptions if you so please.
- customize `config.php` to your liking.

Notes

[1] Cf. “Yahoo ‘helped jail China writer’”, in *BBC News*, September 7, 2005. Available online at <http://news.bbc.co.uk/2/hi/asia-pacific/4221538.stm>. Shi Tao has been released on August 23, 2013, 15 months before the end of his sentence. Cf. “Shi Tao: China frees journalist jailed over Yahoo emails”, in *The Guardian*, September 8, 2013, online at www.theguardian.com/world/2013/sep/08/shi-tao-china-frees-yahoo.

Lilipad Arduino Embroidery

by **Becky Stern** May 2008

<http://fffff.at/lilypad-arduino-embroidery/>

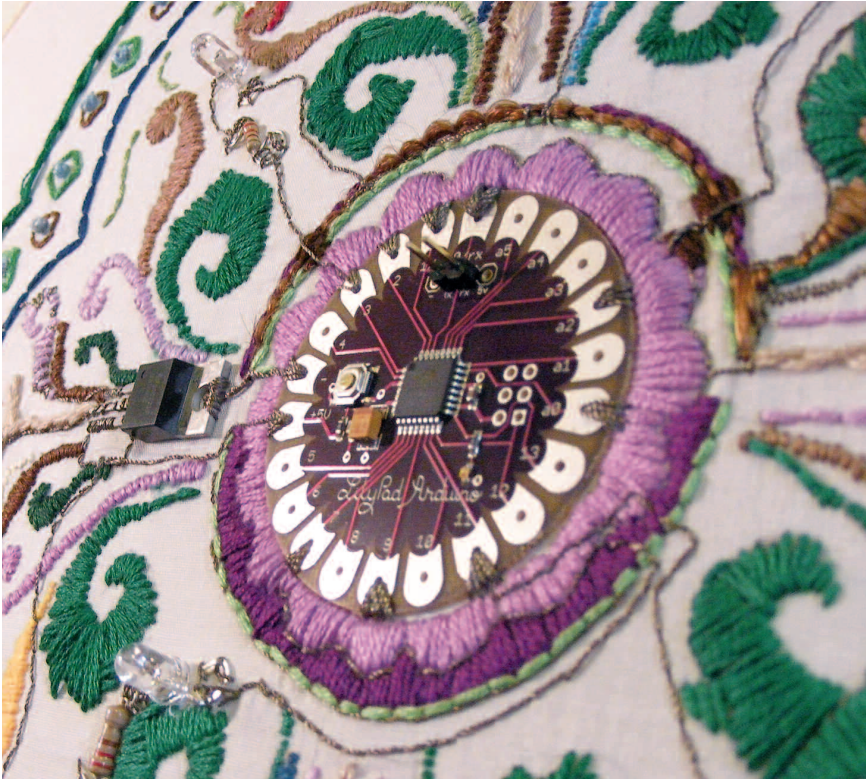

A tribute to Leah Buechley's *LilyPad Arduino*, a microcontroller board designed for wearables and e-textiles, *Lilipad Arduino Embroidery* uses traditional floss and techniques mixed with lights and sounds generated by the onboard software.

The amount of light sensed by the sensor changes the speed and pitch of the lights and sounds generated.

Move your shadow or hand over it to experience the changes.

RANDY SARAFAN
Virtual Research Fellow

Randy Sarafan is an artist, author and all-around troublemaker. He is a Fellow with F.A.T. Lab, a co-founder of S.F. Media Lab, and the community Manager for Instructables.

His work subverts everyday life with a subtly biting sense of humor.

He shares instructions for replicating his work using stupid open-source licenses such that others might be enabled to fulfill their dreams.

His first book *62 Projects to Make With a Dead Computer* makes theft fun and accessible for a general audience.

He graduated with honors from Parsons School of Design and lives in San Francisco with his delusions.

www.randysarafan.com

The Breathalyzer Microphone

by **Randy Sarafan** August 2008

<http://fffff.at/the-breathalyzer-microphone/>



The breathalyzer microphone is a system for the inconspicuous collection of blood-alcohol content level data sets. In other words, you can measure a person's sobriety with a device, that for all intents and purposes, looks no different than a standard microphone. This tool adds new dimensions of truthiness to any standard interview. It can also easily be adapted for karaoke.

How to make it:

- Step 1: Go get stuff
- Step 2: Remove the wind screen
- Step 3: Loosen the Mic
- Step 4: Take out the switch
- Step 5: Remove the XLR plug
- Step 6: Take out the wiring
- Step 7: Prepare the XLR plug
- Step 8: Prepare the switch
- Step 9: Attach more wires to the XLR plug
- Step 10: Attach more wires to the switch
- Step 11: Reassemble
- Step 12: Test your connections
- Step 13: Prepare the stereo plug
- Step 14: Test your connections... again
- Step 15: Mounting Bracket
- Step 16: Start soldering
- Step 17: Finish soldering
- Step 18: Glue the bracket in place
- Step 19: Put the windscreen back on
- Step 20: Make a discreet datalogger
- Step 21: Program the Arduino
- Step 22: Testing... Testing... Is this thing on?
- Step 23: Taking a reading
- Step 24: Reading the SD card
- Step 25: Have some fun

Full step-by-step instructions on how to make it are available on *Instructables*: www.instructables.com/id/Breathalyzer-Microphone/.

Kung-Fu Talking Jesus and Bald Baby Buddha Buddy

by **Randy Sarafan** August 2008

<http://fffff.at/kung-fu-talking-jesus-and-bald-baby-buddha-buddy/>



Mash-ups are all the rage these days. Taking a bunch of things and smashing them all together is much more than just your mother's recipe for casserole: it is an unharnessed recipe for placing power in dangerous hands. Dangerous, dangerous hands.

Now Jesus has a bunch of powers to start with.

He can be your friend. He can walk on water. He can even kill vampires. But despite all of his powers, Jesus cannot do kung-fu. Ok, apparently he can. A quick google search revealed this pretty clearly. Whatever. This Kung-Fu Jesus fits in your pocket. You'll know that Jesus is always there to protect you.

As with all crazy projects, there are side effects. Crazy, alliterative side effects. Not only did we create a no-holds-barred evangelist, we made a bald baby sculpture who resembles Buddha. Strangely, Buddha is wearing Jesus' old digs.

This holy smash-up was made in serious collaboration with The Notorious Jaques Couscous. We were thinking about sending this dynamic duo to China to spring The Green Chinese Lantern from the clutches of the Chinese state and teach them bitches not to mess with freedom of speech, expression and religion.

How to make it:

- Step 1: Find Jesus (and other supplies)
- Step 2: Remove Kung-Fu Attire
- Step 3: Decapitate the Baby
- Step 4: Makeover!
- Step 5: Operate
- Step 6: Recapitate the Baby. Or is it Jesus?
- Step 7: Clap Loudly Near Others

Full step-by-step instructions are available on *Instructables*: www.instructables.com/id/Kung-Fu-Talking-Jesus-and-Bald-Baby-Buddha-Buddy.

ARAM BARTHOLL
Real Research Fellow

Born in Bremen, Germany, in 1972, he lives and works in Berlin.

Aram Bartholl's work creates an interplay between internet, culture and reality.

The versatile communication channels are taken for granted these days, but how do they influence us? According to the paradigm change of media research Bartholl not just asks what man is doing with the media, but what media does with man. The tension between public and private, online and offline, technology infatuation and everyday life creates the core of his producing. In public interventions and public installations Bartholl examines which and how parts of the digital world can reach back into reality.

Aram Bartholl is a member of the Internet based artist group Free, Art & Technology Lab - F.A.T. Lab. Net politics, the DIY movement and the Internet development in general do play an important role in his work.

Beside numerous lectures, workshops and performances he exhibited at MoMA Museum of Modern Art NY, The Pace Gallery NY and [DAM] Berlin.

His work is represented by DAM Gallery Berlin | Frankfurt and XPO gallery, Paris.

<http://datenform.de/>

China Channel Firefox Add-on

by Tobias Leingruber, Aram Bartholl, Evan Roth

September 2008

<http://chinachannel.ffdf.at/>

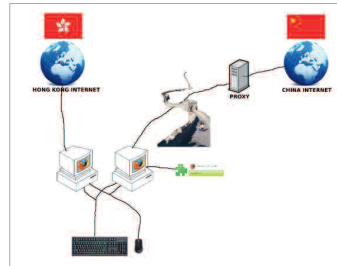

Experience the censored Chinese internet at home!

The Firefox add-on *China Channel* offers internet users outside of China the ability to surf the web as if they were inside mainland China. Take an unforgettable virtual trip to China and experience the technical expertise of the Chinese Ministry of Information Industry (supported by western companies). It's open source, free and easy.

Instructions

Simply follow the 5 steps:

- Step 1: Click the "Download Now" button, confirm install;
- Step 2: after installation confirm restart of Firefox to activate CCFF;
- Step 3: click on the "GO" button, which appears in the top left on the additional tool bar in your Firefox browser to initialize CCFF;
- Step 4: click on the OK button in the popup window to finalize the installation process;
- Step 5: select "CHINA CHANNEL" and click "GO", you will get connected through a random proxy server in China now.

Note: For the most part the Chinese web will feel a lot like home. You will, however, begin to notice differences if you start asking Google about sensitive issues (for example Tiananmen Square protests, or Pro Tibetan issues).

China Channel Firefox Add-on

Exhibition Web 2.0. A gallery implementation of the China Channel Add-On

Web 2.0 is a gallery installation consisting of two internet enabled computers, a hacked mouse and keyboard, and a custom plugin for the popular (and free) Firefox web browser. Two computers are connected to a single keyboard and mouse allowing visitors to control both identical machines at the same time while using just a single input device. The only difference between the two internet terminals is their network connection; one machine is connected to the less restricted internet in Hong Kong, while the other is connected to the internet through a connection point in the mainland of China.

Unlike many tools which enable Chinese people to freely surf the web via connections to computers outside of China, this plugin routes all internet traffic to computers on the inside of the Chinese firewall, allowing web surfers to experience an Internet identical to that of Chinese.

Censorship. The full story and background

The internet is often seen as the borderless, global, everybody connecting, democratic network. But in fact the internet is not the same for everybody, not talking about the people without access. State borders and filtering depending on the country you are living in has become standard in the recent years. For example: Due to copyright issues certain music or TV cast services are only available for the country they are broadcasted in. Have you ever tried to watch BBC HD content not surfing from Great Britain or listening to Pandora music outside of US? But this is trivial compared to certain countries in the world who practice heavy political internet censorship.

States like Saudi Arabia, Iran, Syria, Vietnam, Tunisia and in big scale China do strict political internet censorship by blocking IP addresses and by dynamic content filters. Users in these countries are not able to access regime critical information. Especially China blocking off 1,3 billion inhabitants censors the internet with the support of western technology companies as Cisco, Yahoo or Google. The Golden Shield Project (sometimes referred to as the the Great Fire Wall of China), censors content primarily by blocking IP addresses.

The Internet police in China is estimated to contain over 30,000 workers, and is responsible for blocking content such as Tibetan independence, Taiwan independence, police brutality, the Tienanmen Square protests of 1989, freedom of speech, democracy, religion, and some international news. Just try yourself and see what it is like to surf the web from China.

TV-B-Gone Hoodie

by **Becky Stern** September 2008

<http://fffff.at/tv-b-gone-hoodie/>

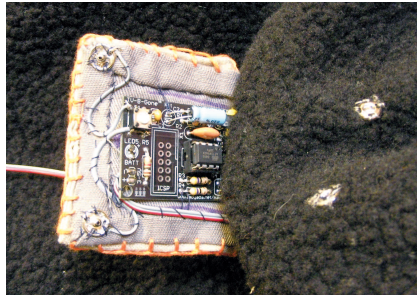

TV-B-Gone is a type of simple universal remote control device for turning off a large majority of the current available brands of television sets. It was created to allow people in a public place to turn off nearby television sets. Its inventor has referred to it as “an environmental management device”. [1]

Whenever I bring my *TV-B-Gone* out to restaurants, I always look real suspicious holding it up and pointing it around, so I’ve been looking for a more subtle and dinner-appropriate solution. I got zippered hoodie sweatshirt from the thrift store which had a convenient logo on the upper left front, complete with rhinestones! I thought the IR LEDs would blend in quite nicely, so I stitched it into the sweatshirt. The batteries are in the pocket. I broke out the pushbutton leads and used conductive thread to sew paths to the edge of the zipper, which has a metal pull. I made two little pads with the thread that are bridged by the zipper pull when it passes by, so all I have to do is zip the sweatshirt up or down to activate the TV turning-off action.

How to make it:

- Step 1: Prep the circuit board and battery holder
- Step 2: Affix the circuit to the sweatshirt
- Step 3: Stitch the traces on the sweatshirt
- Step 4: Stitch the zipper switch
- Step 5: Attach the batteries
- Step 6: Enjoy!

Step-by-step instructions are available on *Instructables*:
www.instructables.com/id/TV-B-Gone-Hoodie/.

Notes

[1] See more on *Wikipedia*: <http://en.wikipedia.org/wiki/TV-B-Gone>.

Double Keyboard

by **Evan Roth** September 2008

<http://ffff.at/double-keyboard/>



Double your productivity by connecting a single keyboard to two computers! It's simple: one keyboard, two USB connections, infinite possibilities. Each finger stroke will be twice as powerful with this keyboard mod. This is a low cost, no soldering, project that will double your key strokes per hour in minutes.

Double Keyboard is a follow up of the *Double Mouse* project (2006). Together they provide a complete double computing system.

How to make it:

- Step 1: MATERIALS / PARTS LIST
- Step 2: CUT CABLES
- Step 3: EXPOSE WIRES
- Step 4: TWIST AND TAPE
- Step 5: WRAP CONNECTIONS
- Step 6: CONNECT USB / PS/2 ADAPTERS
- Step 7: USES?

Step-by-step instructions are available on *Instructables*:
www.instructables.com/id/DOUBLE-KEYBOARD.

Double Keyboard and *Double Mouse* have been used for the installation version of the *China Channel Firefox Add-on*. *Double Mouse* have been used by Evan Roth for the project *9 to 5 Paintings* (2006). The paintings are generated seamlessly on one computer when you are surfing, reading emails and working on the other, by taking advantage of the same mouse clicks.

Low Tech Rick Roll

by **Tobias Leingruber** November 2008

http://tobi-x.com/kate_moss_nude/



Low Tech Rick Roll is a low tech, dirty style version of the Rick Roll meme: a simple webpage featuring an animated gif of the infamous Rick Astley Youtube video displayed fullscreen, a midi version of the song Never Gonna Give You Up, and the animated text "You've Been Rick Rolled!". Typically, the Rick Roll video appears when following a hyperlink which is seemingly relevant to the topic at hand, or which promises a hot content.

Low Tech Rick Roll can be found at the following URL:
http://tobi-x.com/kate_moss_nude/.

Pirates of the Amazon

by Tobias Leingruber December 2008

<http://ffff.at/pirates/>



“How can you compete with free? You cant!”

— LAWRENCE LESSIG

“Lets build a world we are proud of, not just a profitable world for a few very large media companies.”

— BREWSTER KAHLE, founder of the *Internet Archive*

The Firefox add-on *Pirates of the Amazon* [1] inserts a “download 4 free” button on Amazon, which links to corresponding Piratebay BitTorrents. The add-on lowers the technical barrier to enable anyone to choose between “add to shopping cart” or “download 4 free”. Are you a pirate?

Instructions

Prepare your ship in 4 steps:

Step 1: To be able to download BitTorrent you have to have a BitTorrent software installed. Good ones are uTorrent for Windows and Transmission for Mac and Linux.

Step 2: Click the “Download Now” button, click “allow”, confirm install.

Step 3: Confirm Firefox restart to activate the add-on.

Step 4: Go to Amazon and enjoy having the choice between “add to shopping cart” and “download 4 free”.

Background

This add-on provides a simple interface to torrent files, combining a torrent search engine with the information features offered by Amazon.

Pirates of the Amazon

It also shows that there is an alternative to buying overpriced media-products from companies relying on outdated distribution techniques. *Pirates of the Amazon* offers to be a counterpart to the current models of media distribution. “Redistribute the wealth” by bringing together one of the world’s biggest e-commerce platforms with the world’s largest BitTorrent tracker.

Established media distributors claim that peer-to-peer networks are the death for entertainment media itself. These claims sound quite similar to the ones about the printing press or the invention of VCRs or CDR-Drives. The truth is that the possibility of information sharing inspires people to start creating, remixing and enriching the media landscape.

About

There have been similar browser modifications on the internet for quite a while such as the “IMDB popular torrent search Firefox Greasemonkey script” that adds links to torrent search results on the IMDB website. The “OU Library Amazon Greasemonkey Script” uses Amazon as an interface to find books at public libraries. The project *Amazon Noir* (2006) by the net artists UBERMORGEN.COM, Alessandro Ludovico and Paolo Cirio “liberated” dozens of books from Amazon by overusing the Amazon “search inside” function.

We are not affiliated with The Pirate Bay, and do not host or even link to any illegal content. This artistic project addresses the topic of current media distribution models vs. current culture and technical possibilities. When you choose to install the add-on, you modify the local behavior of your web browser. If you download content through a torrent link, provided by The Pirate Bay, you might violate current copyright laws.

Notes

- [1] The project was developed by Tobias Leingruber and another student at the Media Design M.A. course at the Piet Zwart Institute of the Willem de Kooning Academy Hogeschool Rotterdam, the Netherlands, under the supervision of tutor Denis Jaromil Rojo and course director Florian Cramer. One day after publishing they received a take down request by the legal department of Amazon.com. Since then, the add-on is not available anymore. The text below is an edited version of the one featured on the original website of the project, now archived at <http://ffff.at/pirates/>. The project's website (<http://pirates-of-the-amazon.com/>) now hosts a documentation of the project, including feedbacks and press coverage.

STEVE LAMBERT
Communications Minister

Steve Lambert was a Senior Fellow at New York's Eyebeam Center for Art and Technology from 2006 to 2010. He is s a perpetual autodidact with (if it matters) advanced degrees from an reputable art school and respected state university.

He made international news after the 2008 US election with The New York Times "Special Edition," a replica of the "paper of record" announcing the end of the wars in Iraq and Afghanistan and other good news. He has collaborated with groups from the Yes Men to the Graffiti Research Lab and Greenpeace. He is also the founder of the Center for Artistic Activism, the Anti-Advertising Agency, and Add-Art, a Firefox add-on that replaces online advertising with art.

Steve's projects and art works have won awards from Prix Ars Electronica, Rhizome/The New Museum, the Creative Work Fund, Adbusters Media Foundation, the California Arts Council, and others. Lambert's work has been shown everywhere from museums to protest marches nationally and internationally, featured in over fourteen books, four documentary films, and is in the collections of The Sheldon Museum, the Progressive Insurance Company, and The Library of Congress. He is an Assistant Professor at SUNY Purchase.

<http://visitsteve.com/>

Impressionist Me, Now Me

by **Steve Lambert** December 2008

<http://fffff.at/impressionist-me-now-me/>

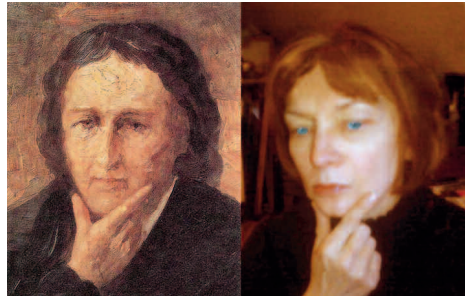

Impressionist Me, Now Me

You may have heard about *Young Me Now Me*, a fun Ze Frank thing [1]. After discovering the painting of Georges Emile Lebacq on the left and its remarkable likeness to my visage, we at FFFFF.at developed something with a little more dignity and class, it's called: *Impressionist Me, Now Me*.

Get out that new digital camera you just unwrapped, do some hunting online and get into it.

Here's the rules:

1. Search commons.wikimedia.org or other sites for a historical painting, drawing, or early photograph that looks like you (it's easier than you think). It doesn't have to be an impressionist painting, that's just what we started with.
2. Create a photo of you today where you recreate the pose and scene as best you can. Try to dress the same.
3. Put the two images side by side and upload it into the comments!

Here's some to get us started:

Georges Emile Lebacq and Steve Lambert
Becky Stern and Madame Cézanne
Claire Jervert and unkown
Van Gogh and Evan Roth
Van Gogh and Jamie Dubs
Nate Graham chills with Diego Rivera
Michele Meets Dora Wheeler

Notes

[1] Available online at www.zefrank.com/youngmenowme, *Young Me Now Me* is a website where you can upload pictures of you from the past compared with pictures of you at the present time (usually shot with the first image in mind).

How to Make Permanent Asphalt Mosaics with Linoleum

by **Becky Stern** January 2009

<http://fffff.at/asphalt-mosaics-with-linoleum/>

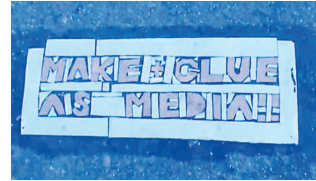
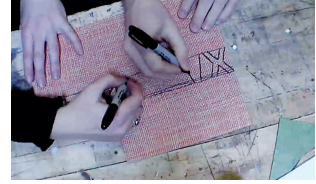
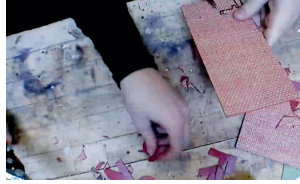
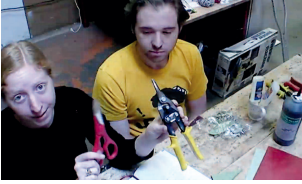

Linoleum asphalt mosaics, also called Toynbee Tiles, [1] are artworks permanently embedded in pavement. In this video [2] I'll show you how to construct your own from inexpensive materials. You can get real linoleum (don't use vinyl flooring) for this project by ordering free samples online. [3] By cutting out a mosaic design in the linoleum and sandwiching it between layers of paper, wood glue, and asphalt crack filler, you can affix the mosaic very permanently to any asphalt surface, such as your driveway. You may choose to use a heat gun to make the linoleum easier to cut, or even a laser cutter.

The earliest examples of these tiles were found in the 70s and 80s on streets in Philadelphia, all bearing the same (or very similar) message: "Toynbee idea / in Kubrick's 2001 / resurrect dead / on planet Jupiter." They are speculated to have been created by the same person until they began to gain a following.

Notes

[1] Cf. http://en.wikipedia.org/wiki/Toynbee_tiles.

[2] Available online at <https://vimeo.com/2983090>.

[3] For example, at www.themarmoleumstore.com.

The Joydick

by Randy Sarafan and Noah Weinstein February 2009

<http://fffff.at/the-joydick/>



The *Joydick* [1] is a wearable haptic device for controlling video gameplay based on realtime male masturbation. Through the use of a carefully designed strap-on interface, the user's penis is converted into a joystick capable of moving the character onscreen in all four cardinal directions. For games requiring the fire button, a separate ring can be worn which converts hand-strokes into button presses.

The Theory

The “core mechanic” is the action a player does over and over again during game play. This may be rolling dice or it may be frantically pressing a button. Although, this behavior tends to vary, the objective of this behavior is always the same, to win the game.

Our impetus to win can be seen as a drive towards transcendence.

A transcendence that is both over death and, in a sense, a metaphorical death. Winning a video game is much like what Martin Heidegger referred to as becoming a “being towards death.” That is a self-realized individual who has overcome uncertainty in life, reconciled their place in the universe and has acknowledged death within their life.

This simultaneity of both transcendence in life and the acknowledgment of death is also encountered during what the French like to call “la petite morte” or in English, “the little death.” This is the refractory period following sexual climax in which a person can achieve no further orgasm and is filled both with pleasure and melancholy.

It would be reasonable to assert that the tension that builds during gameplay and the release achieved through victory are similar to the events leading up and through a sexual orgasm.

The Joydick

Bringing us full circle, aside from sharing a similar goal and end result, the much more obvious relation between video gameplay and what this haptic technology provides, an expression of masculine sexuality, is that they are both driven by a core mechanic. In the case of male masturbation, the core mechanic is the repeated stimulation of the nerve endings of the penis.

In fact, the similarities between the mechanics and objectives of both sex and video games are so striking that it may be fair to say that gameplay, particular video games, are driven by displaced sexual energy.

This hypothesis can help explain why young, sexually-frustrated males are the largest demographic in the gaming world and why men in general are two times more likely to be avid gamers than women. It is also true that energy misdirected towards video games has been known to destroy marriages and tear apart relationships. In fact, *Woman's Health* has published an article called "Video Games and Foreplay" in their "Sex and Relationships" column in which they state that women should play more video games as a way to proactively engage with their male partner. [2] What is striking about this, is that by likening video gaming to foreplay and claiming it as a trust-building exercise, *Women's Health Magazine* is implying that video games, in some circumstances, have taken the role of actual sexual foreplay. The link between video gameplay and male sexual stimulation seems quite clear. It is therefore somewhat surprising that (it would seem) up until now, no one has taken the logical step forward and used repeated sexual stimulation as a means for controlling a video game. Although a number of people have used game controllers as stimulators by creating devices that are reactive to gameplay, a majority of these systems are directed towards female stimulation and are possibly designed as a way to engage frustrated partners in the masturbatory nature of video gameplay. Such thoughts were also alluded to by Jane Pinckard while reviewing the Japanese game *Rez* which is often sold with a "trance vibrator." [3]

Given that most sexual gaming interfaces are responsive to gameplay and directed towards female stimulation, the *Joydick* is a substantial breakthrough and brings the first proactive male-oriented sexual gaming interface to the world. The *Joydick* stimulates males both mentally and physically by combining the core mechanic of gameplay with the core mechanic of sexual stimulation. [4]

Notes

[1] Done in collaboration with Instructables user noahw (cf. www.instructables.com/member/noahw).

[2] Cf. "Joysticks for Two", in *Women's Health*, online at www.womenshealthmag.com/sex-and-relationships/video-games-and-foreplay.

[3] Jane Pinckard, "Sex in Games: Rez+Vibrator", in *game+girl=advance*, October 26, 2002, online at www.gamegirladvance.com/2002/10/sex-in-games-rezvibrator.html.

[4] Step-by-step instructions to make your own *Joydick* are available here: http://projects.sfmedialabs.com/?page_id=77.

GERALDINE JUÁREZ
Becaria de Investigación

**Born in Mexico City, de-schooled in New York City.
Based in Göteborg.**

I work with technologies and piracies to interact with and reflect on spaces that emerge from the endless tensions between information, property and power. I am fellow of FAT LAB, half Forays, founder of the DataSlöjd studio and member of the Electronics Studio at KKV in Göteborg.

My practice developed during two generous fellowships in Eyebeam NYC, where I was awarded the AIR fellowship (2002/2003) and the Senior Production Lab Fellowship (2006/2008).

Also I've been resident artist at inCUBATE in Chicago (2008), Timelab in Belgium (2010), JA.Ca in Brazil (2010), Fabrikken in Copenhagen (2013) and I'm one of the recipients of the Makers Muse Award 2011 from the Kindle Project.

My work has been shown internationally at solo shows such as "Some people just want to see the market crash" at Science Friction in Copenhagen and collective exhibitions like "Piracy Now" (London), "Economics and the Immaterial" (Dublin), "Interference and Other Options" in Eyebeam (NYC), "Los Impolíticos" at Pan (Naples), Transmediale (Berlin 2009 and 2010), and festivals such as ALTCPH, Píksel, Futuresonic, Pixelache, Conflux, Click and Transitio.

www.simple-mechanisms.com

Kopyfamo'

by **Geraldine Juárez** March 2009

<http://www.ffff.at/kopyfamo/>

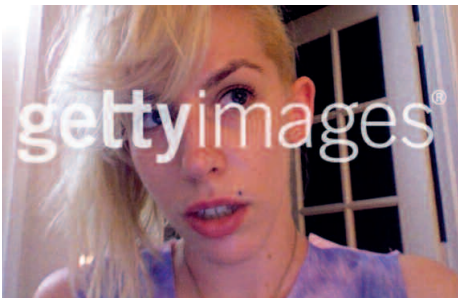

Kopyfamo'. Free Copyright for the Masses is a simple web tool that adds the most valuable copyright watermarks to your content for free. Just upload your image and adorn it with one of four prestigious watermarks to give them instant credibility.

The Kopyfamo' database is available here:
<http://www.ffff.at/fuckflickr/kopyfamo/>.

SelfControl

by Steve Lambert March 2009

<http://ffff.at/selfcontrol-parental-controls-for-grown-ups/>

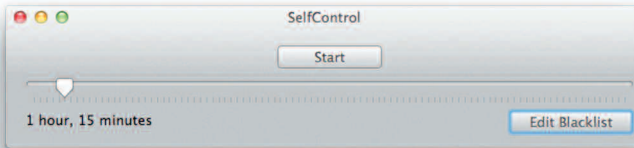

Is email a distraction? *SelfControl* is an OS X application which blocks access to incoming and/or outgoing mail servers and websites for a predetermined period of time.

For example, you could block access to your email, Facebook, and Twitter for 90 minutes, but still have access to the rest of the web.

Once started, it can not be undone by the application, by deleting the application, or by restarting the computer – you must wait for the timer to run out.

Created while at Eyebeam Center for Art and Technology.

Thanks to Charlie Stigler for developing the application.

SelfControl is Free Software under the GPL.

It is available for download here: <http://selfcontrolapp.com/>.

Source code is available on Github: <https://github.com/slambert/selfcontrol/>.

LilyPad Arduino Blinking Bike Safety Patch

by **Becky Stern** April 2009

<http://fffff.at/fatlab-blinking-bike-bag-patch/>

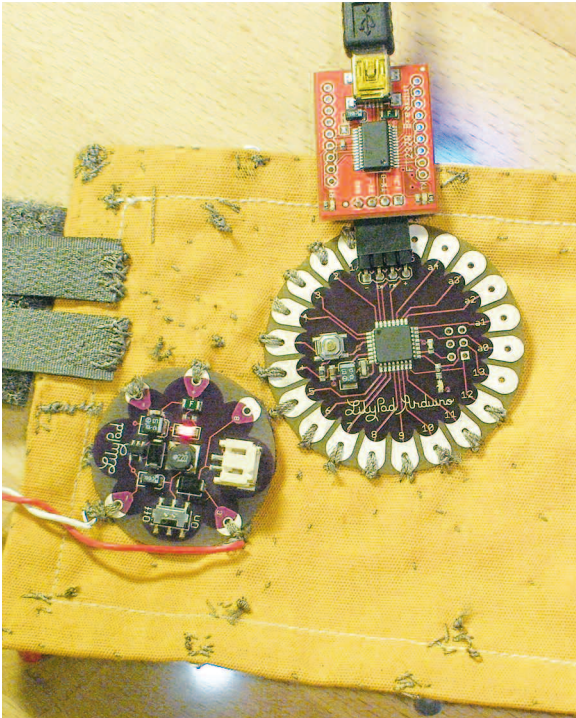

If you have some embroidered patches such as the *F@Patches*, you may like to add flashing LEDs to them and put them on your backpack for fun and safety. I used a LilyPad Arduino with a rechargeable lithium-polymer battery for flatness and re-usability. The LEDs blink in a marquee pattern, two at a time, in patriotic red, white and blue, in fitting with this year's "Re-Make America" Maker Faire theme.

How to make it:

- Step 1: Materials and Tools
- Step 2: Sew the LED grounds
- Step 3: Sew the power supply and LilyPad
- Step 4: Sew the LilyPad pins to the LED positive leads
- Step 5: Program the Board
- Step 6: Affix with Velcro
- Step 7: All Done!

Step-by-step instructions are available on *Instructables*:
www.instructables.com/id/LilyPad-Arduino-Blinking-Bike-Safety-Patch.

KANYE VISION BOOKMARKLET

by Tobias Leingruber and Evan Roth May 2009

<http://fffff.at/kanye-vision-bookmarklet/>

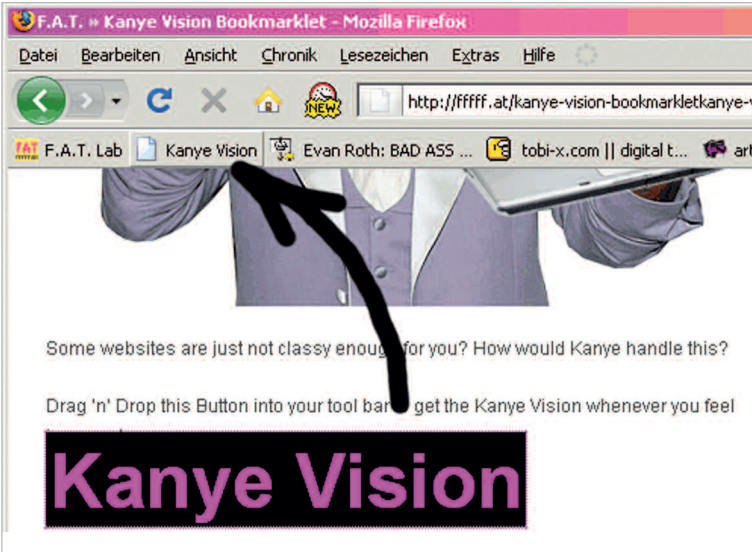

The *KANYE VISION BOOKMARKLET* allows you to “view the internet the way Kanye sees it.” Once you added the bookmarklet to your favorite browser bookmarks bar, you just have to click on it while visiting a given page to see it through Kanye’s striped glasses.

KANYEFY BOOKMARKLET

by **Greg Leuch and Evan Roth** May 2009

<http://ffff.at/kanyefy-text-bookmarklet/>

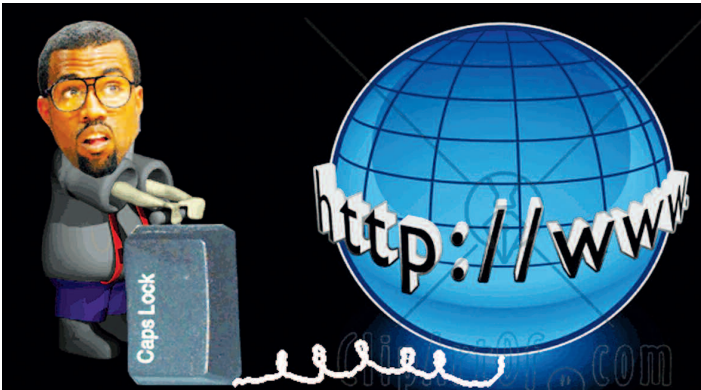

The *KANYEFY BOOKMARKLET* turns the text in any given webpage all-caps. You just have to drag the bookmarklet to your bookmarks bar to make your page “yeezy-approved”.

Source code:

```
function KANYEFY() {
  jQuery.fn.KANYEFY = function(c) {

    function eval_sentence(val) {
      if (val && val != '') {
        return val.replace(/(?!<)(\!)/ig, '$1!!!!!!').replace(/\.\/ig,
        '.....').replace(/\/ig, '?????');
      }
    }
  }
}
```

KANYEFY BOOKMARKLET

```

return this.filter(function() {if (this.nodeType == 1) {var g =
this.tagName.toLowerCase(); return !(this.className == 'unKANYEIFY' || g
== 'style' || g == 'object' || g == 'embed' || g == 'head' || g == 'img'
|| g == 'script');} else {return true;}}).each(function() {
  if (this.nodeType == 3) {
    if (this.nodeValue.replace(/\\s/ig, '') != '') {
      jQuery(this).after( eval_sentence(this.nodeValue) );
      this.nodeValue = '';
    }
  } else if (this.nodeType == 1) {
    if (jQuery(this).children().length > 0) {
      jQuery(this).contents().KANYEFY();
    } else if (jQuery(this).children().length == 0) {
      jQuery(this).html( eval_sentence(jQuery(this).text()) );
    } else {
      // what do you want me to do?
    }
  }
});
};

jQuery('html').KANYEFY();
document.body.style.textTransform = 'uppercase !important';
document.body.innerHTML += '<style id="KANYEFY" type="text/css">html,
body {text-transform: uppercase !important;}</style>';
}

// Load jQuery only if not present on site.
if (typeof(jQuery) == 'undefined') {
  var GM_JQ = document.createElement('script');
  GM_JQ.src = 'http://jquery.com/src/jquery-latest.js';
  GM_JQ.type = 'text/javascript';
  document.getElementsByTagName('head')[0].appendChild(GM_JQ);
  function load_jQuery() {if (typeof(jQuery) == 'undefined')
{window.setTimeout(load_jQuery,100);} else {KANYEFY();}}
  load_jQuery();
} else {
  KANYEFY();
}

```

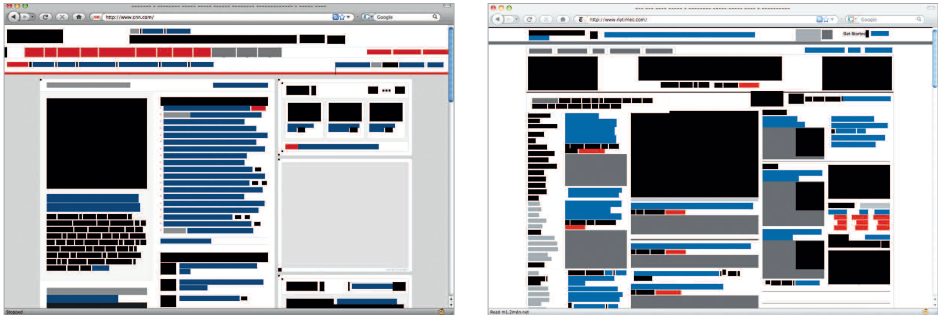
Ctrl+F'd**by Greg Leuch** July 2009<http://ffff.at/ctrlfd-censoring-the-interwebs/>

With recent mistakes by companies and organizations not knowing how to properly censor online documents, it is easy to see why people believe the text they can't see can't be read. And with computer illiterate talking heads like Rush Limbaugh [1] or internet illiterate censorship advocates like Ursula von der Leyen, [2] it is easy to befuddle them with the appearance of censored text on the web pages they commonly visit.

Ctrl+F'd is a playful experiment in "censoring" a web page by hiding text and images behind blocks. The project is available as a bookmarklet, a Firefox extension, or as a JavaScript code for any user's website.

The code is available for free on Github: <https://github.com/gleuch/ctrl-f-d>

Notes

- [1] Rush Hudson Limbaugh III is a conservative American radio talk show host and political commentator. Since 1988 he broadcasts the The Rush Limbaugh Show, the highest-rated talk-radio program in the United States. In 2009, Rush Limbaugh falsely claimed that Democrats "have reformatted the [economic recovery] bill" - they've made it a PDF file when they posted it. ... And, so, you can read every page, but you cannot keyword search it. It's not a text file as legislation normally is as posted on these public websites. They don't want anybody knowing what's in this." In fact, as Adobe Systems notes of PDFs: "You can run a search using either the Search window or the Find toolbar. In either case, Reader searches the PDF body text, layers, form fields, and digital signatures." Cf. Eric Hananoki & Greg Lewis, "Memo to Limbaugh: Try CTRL+F before blasting Dems for purportedly unsearchable bill", In *Media Matters*, February 13, 2009, online at <http://mediamatters.org/research/2009/02/13/memo-to-limbaugh-try-ctrlf-before-blasting-dems/147491>.
- [2] Ursula Gertrud von der Leyen is a German politician of the conservative Christian Democratic Union. Since 2005, she served as Federal Minister of Family Affairs in the First and Second Cabinet Merkel. In her fight against internet child pornography, she created the basic infrastructure for extensive censorship of websites deemed illegal by the Federal Criminal Police Office of Germany (BKA). For more information, cf. http://en.wikipedia.org/wiki/Ursula_von_der_Leyen.

Speed Project

by **Aram Bartholl** September 2009

<http://fffff.at/speed-project/>

Do more projects in less time!
Do Speed Projects!

Instead of working on some GREAT piece for a whole year do faster projects. Do Speed Projects! Start labeling your latest work with the official Speed Project stamp. Check the amount of time you needed for full production time including online publication. A Speed Project may not take longer than 8h max. Adding up time fragments is not allowed, once you started the clock is running (skip lunch or better do a project during lunchtime ;-)

Download the template now [1] and release something today! Be fast!
Go go go !
Setting up this project took me roughly one hour.

Notes

- [1] In October 2009, Greg Leuch made a *Speed Project Widget Generator*, that allows you to get your own speed project badge, quickly and easily. Of course, it is a speed project too. Online at <http://fffff.at/speed-project-widget/>.



Fuck 3D

by **Aram Bartholl** September 2009

<http://ffff.at/f-a-t-nika/>

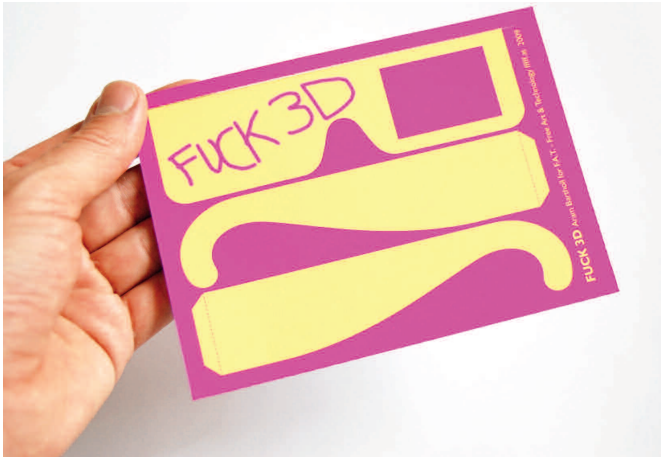

Are you sick of the 3rd dimension? Are you annoyed by the people and world around you? Do you feel sometimes dizzy walking home in the 3rd dimension? But you DO enjoy your 2D – Facebook / Twitter / browser life much more than the dirty world out there?

F.A.T. brings to you a brand new solution!!! Just switch your whole life to 2D. Get a pair of FUCK 3D glasses, loose the 3rd dimension and enjoy full 2D!!! It never has been so easy!! Life is so much better!!

Download FUCK 3D DIY-set:
<http://ffff.at/download/FUCK3D.pdf>



CHRIS SUGRUE
Research Fellow

Chris Sugrue is an artist and programmer developing interactive installations, audio-visual performances and experimental interfaces. Her works have investigated topics such as artificial life, eye-tracking and optical illusions. She has exhibited internationally in such festivals and galleries as Ars Electronica, Sónar Festival, Pixel Gallery, Medialab-Prado, Matadero Madrid, and La Noche En Blanco Madrid.

Sugrue holds a Masters of Fine Arts in Design and Technology from Parsons School of Design. She worked as a creative engineer at the Ars Electronica Futurelab and was the recipient of a year-long fellowship at the Eyebeam Art and Technology Center in New York.

She has taught courses in the Design and Technology department at Parsons School of Design, the Interface Culture program at the KunstUniversität in Linz, Austria, and numerous workshops on visual and creative programming.

<http://csugrue.com>

EyeWriter

2009 – 2010

<http://eyewriter.org>

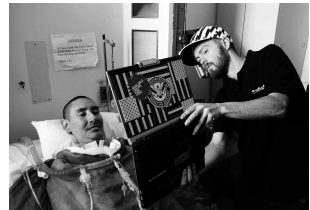
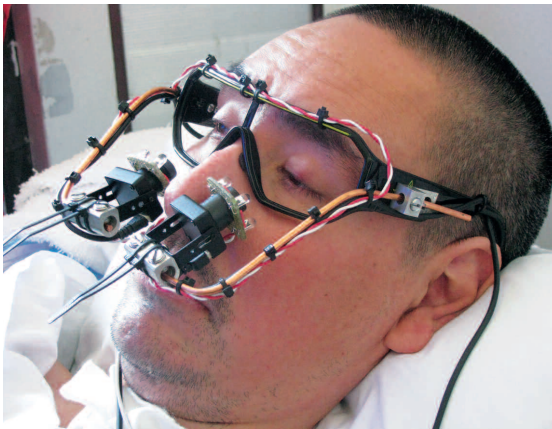

In 2009, members of Free Art and Technology (F.A.T.), OpenFrameworks, the Graffiti Research Lab, and The Ebeling Group communities have teamed-up with a legendary LA graffiti writer, publisher and activist, named TEMPT1. TEMPT1 was diagnosed with ALS in 2003, a disease which has left him almost completely physically paralyzed... except for his eyes. This international team – including Zach Lieberman, James Powderly, Evan Roth, Chris Sugrue, Tempt1 and Theo Watson – worked together to create a low-cost, open source eye-tracking system that will allow ALS patients to draw using just their eyes.

EyeWriter

The long-term goal is to create a professional/social network of software developers, hardware hackers, urban projection artists and ALS patients from around the world who are using local materials and open source research to creatively connect and make eye art.

The *EyeWriter* software is two parts — an eye-tracking software designed for use with low-cost glasses, and a drawing software designed for drawing with eye movements. The software for both parts has been developed using openFrameworks, a cross platform c++ library for creative development. The eye-tracking software detects and tracks the position of a pupil from an incoming camera or video image, and uses a calibration sequence to map the tracked eye/pupil coordinates to positions on a computer screen or projection. The eye-drawing software is designed to work with the EyeWriter tracking software as well as commercial eye-trackers. The tool allows you to draw, manipulate and style a tag using a time-based interface so that triggering buttons or creating points for drawing is achieved by focusing on the position for a given amount of time. Thanks to these two powerful tools, TEMPT1 eye movements can be converted into his famous tag, and turned into a digital image or projected live onto a building.

Since its development, *EyeWriter* has been publicly presented in various occasions, both in urban spaces and in exhibition spaces.

In October 2009, TEMPT1's tag went live again during the BLK River Festival in Vienna, projected on the tallest building Vienna has to offer; along the same days, the project was on show at the CREAM International Festival for Arts & Media in Yokohama, Japan, as part of the Graffiti Research Lab exhibition, and in Kyoto. In february 2010, it was nominated for the Design Museum London's *Design of the Year Show*.

Thanks to its open source nature, the project also spawned related projects, including *MumbaiWriter*, by James Powderly, and *LiveWriter*, by Theo Watson. In 2010, Zachary Lieberman, Ito Takayuki, Golan Levin and Kyle McDonald developed the *EyeWriter 2.0* with a glasses free design, using a hacked PS3 Eye camera with two external LED clusters to make reference glints in the eye.

MumbaiWriter

by James Powderly January 2010

<http://ffff.at/mumbaiwriter/>



In January 2010, the *EyeWriter* development team went to Mumbai, India to take part in TechFest2010. Instead of bringing the *EyeWriter* with them, they developed a GML-compliant [1] version of it with the best engineers in the near-east from IIT Bombay. Here comes the *MumbaiWriter*: a solder-less version of *EyeWriter* made from parts and tools found locally in Mumbai. In case you would like to make one, here are a few advices on how-to haggle down a market vendor in bad Hindi, written phonetically:

– You go into a market and you approach a vendor who is selling something you want. Point at the item and say...

You: “Kidna pasa” — how many pennies for this?

– the vendor is offended. You basically just said they are selling cheap shit. But everyone respects an arse, so they give you a decent price in rupee.

You: “Bo jadda” — too much!

– What did you just say? The vendor should be shocked a dumb foreigner like yourself can speak any Hindi at all and come back with a lower price out of pity...

You: “Com corro” — a little less.

– Are you serious? If the magic is in the air, they may give you an even lower price...

You: “Or com corro” — a little more less?

– WTF? You’re breaking my balls here! Whatever the vendor says next, you should take it. Its probably as low as its going to go for you.

You: “T.K.” — OK.

Notes

[1] GML stands for Graffiti Markup Language, a XML file type developed by Theodore Watson, Jamie Wilkinson, Chris Sugrue and Evan Roth, and specifically designed for archiving graffiti tags. For more info, cf. pp. 72 - 73.

LiveWriter

by Theo Watson November 2010

<http://ffff.at/eyewriter-2-0-robot-arm-livewriter/>

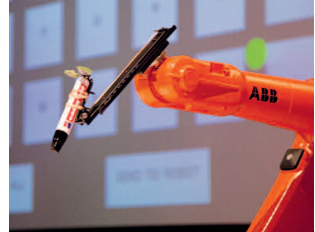
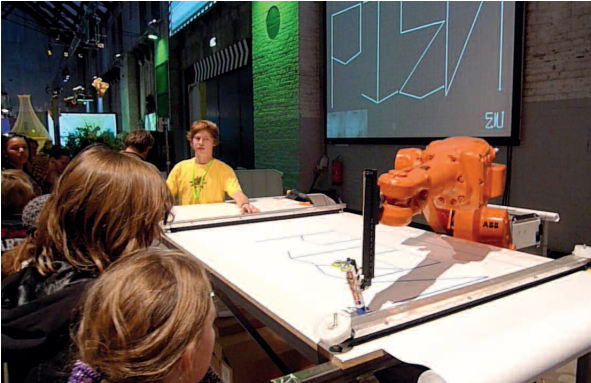

Originally developed for the 2010 Cinekid festival in Amsterdam, the *LiveWriter* allowed children visiting the festival to write their name and have it drawn by a giant, bright orange robot arm onto paper which they could take home with them. The system allowed them to both draw with their eyes and type with a keyboard. The keyboard was by far the most popular with the kids and it would send the letters they made to the robot using a typeface designed by paralysed graffiti artist TEMPT1, made with the original *EyeWriter* system.

Made by Theo Watson in collaboration with Golan Levin, Gijs Van Wee and Jan Van Laar (Polynorm), *LiveWriter* is an open source project (made with openFrameworks) that combines two other F.A.T. fellows projects: the *EyeWriter* and the *GML Robotagger* by Golan Levin, an industrial robot arm programmed with GML.

GOLAN LEVIN
Virtual Research Fellow

Golan Levin seeks to shape culture through the design of open systems that awaken people to their potential as creative agents. He is currently an Associate Professor of Art at Carnegie Mellon University, with courtesy appointments in Design and Computer Science; there, he teaches computation arts and researches new intersections of machine code and visual culture.

Since 2009 he has also served as Director of the Frank-Ratchye STUDIO for Creative Inquiry, an arts-research laboratory dedicated to supporting atypical, interdisciplinary and inter-institutional projects at the intersection of arts, sciences and technology.

<http://www.flong.com>

GML – Graffiti Markup Language

2010 – ongoing

<http://www.graffitimarkuplanguage.com/>

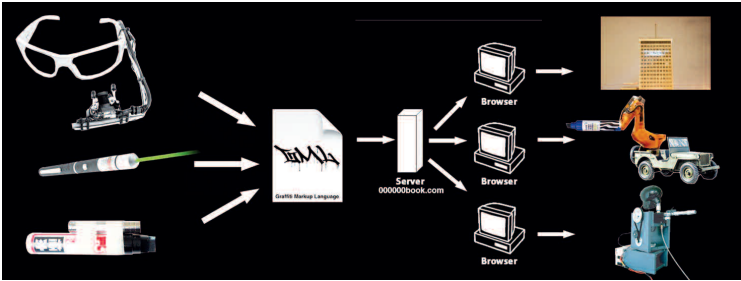

<GML> **</GML>**



Graffiti Markup Language (.gml) is a universal, XML-based, open file format designed to store graffiti motion data (x coordinates, y coordinates and time). The format is designed to maximize readability and ease of implementation for even hobbyist programmers, artists and graffiti writers. Beyond storing data, a main goal of GML is to spark interest surrounding the importance (and fun) of open data and introduce open source collaborations to new communities. GML is intended to be a simple bridge between ink and code, promoting collaborations between graffiti writers and hackers. GML is today’s new digital standard for tomorrow’s vandals.

GML was originally created by F.A.T. Lab members Evan Roth, Chris Sugrue, Theo Watson and Jamie Wilkinson. It is the point of convergence of many graffiti-related projects by F.A.T. fellows, who have been obsessed with the merge of hacking and graffiti for long. In 2005, during their fellowship at the Eyebeam OpenLab, Evan Roth and James Powderly founded the Graffiti Research Lab, an art group dedicated to outfitting graffiti writers, artists and protesters with open source technologies for urban communication. The GRL launched projects such as *LED Throwies*

GML – Graffiti Markup Language

(2006), that allows people to create non-destructive light graffiti by throwing a “throwie” (made by taping together a lithium battery, a 10mm diffused LED and a rare-earth magnet) onto metallic urban objects; and *L.A.S.E.R. Tag* (2007), a computer vision system paired with a projector that enables one to write on walls using a high-power laser pointer. Since 2004, Roth is also working on *Graffiti Analysis*, an extensive ongoing study in the motion of graffiti in which custom software designed for graffiti writers creates visualizations of the often unseen gestures involved in the creation of a tag. When GML was released, projects such as *Graffiti Analysis*, *L.A.S.E.R. Tag* and *EyeWriter* have been updated to be GML compliant.

In January 2010, Roth announced on the F.A.T. website a GML week, that brought to the release of various GML related projects. Another GML week was organized at the end of August 2010, when the first release of the *GML Spec Document* was published. The second GML week also saw the launch of the GML Field Recorder Challenge: a 1,200 € prize (entirely funded by Constant, a non-profit interdisciplinary arts-lab based in Brussels) for the realization of an easily reproducible DIY device that can unobtrusively record graffiti motion data during a graffiti writer’s normal practice in the city. The winning project will be the *GML Recording Machine* (2011) by Turkish artist Muharrem Yildirim.

FatTag Deluxe

by Theo Watson and KATSU January 2010

<http://fffff.at/fattag-deluxe-katsu-edition/>



In March 2009, Theo Watson released the *FatTag*, a simple graffiti tagging iPhone app with accelerometer-based dripping paint. In January 2010, for the GML Week, he launched the *FatTag Deluxe – Katsu Edition*, co-created with NYC graffiti artist Katsu.

The update includes many new features: multiple default backgrounds, additional background selection from camera or photo library, scale, rotate, angle, opacity options for realistically overlaying tag onto camera image, multiple pen/brush tips and colors, full accelerometer based drips, and speed based thickness. Furthermore, GML and screenshots can be uploaded to FAT's *000000book.com*, an open repository for sharing and archiving motion captured graffiti tags. With a small hack of the code, the app can be connected to a projector, and used to make live public interventions in real time from the iPhone.

#000000book.com

by **Jamie Wilkinson, Evan Roth, Theodore Watson, Chris Sugrue and Todd Vanderlin** January 2010

<http://000000book.com>



#000000book.com (“Blackbook”) is a website for archiving and sharing motion-captured graffiti tags. Tags are saved as Graffiti Markup Language (GML) files, which can be created with freely available software like *Graffiti Analysis*, *Laser Tag*, and with iPhone apps such as *DustTag* and *FatTag Deluxe: Katsu Edition*.

Anyone can easily upload GML to #000000book through an open API, and the aforementioned iPhone apps have #000000book.com upload built-in – download the app, start tagging, tap ‘upload’, and see your work immediately featured on the frontpage.

By registering on #000000book.com you can link your iPhone (or any other device) and your uploads will be automatically added to your account. While browsing the site you can also mark tags as ‘favorites,’ and leave comments. And each user has a profile page that shows off their bling. On the other hand, programmers and artists can download your GML data and render the tags in any conceivable way, shape, or form. The project aims to bring together two seemingly disparate communities that share an interest hacking systems, whether found in code or in the city: graffiti writers and computer programmers.

A “black book” is, in writers’ jargon, a graffiti artist’s sketchbook, often used to sketch out and plan potential graffiti, and to collect tags from other writers. #000000 is the hexadecimal representation of black, commonly used in mathematics and computer science.

Since the launch of the database, thousands of tags have been uploaded, and more than twenty GML-based projects have been archived, both by F.A.T. members and other artists and designers.

Robotagger

by **Golan Levin** January 2010

<http://fffff.at/gml-robotagger/>



A labor-saving device for graffiti artists. An assistive tool or telematic proxy for taggers working in harsh environments. Long-needed relief for graffiti artists with RSI. Or simply, pure research into as-yet-untrammelled intersections of automation and architecture. We give you: the *ROBOTAGGER*, an industrial robot arm programmed with GML, the new “Graffiti Markup Language” created by Evan Roth and pals at the FAT Lab.

This quick project came together over the past weekend in CMU’s Digital Fabrication Laboratory (dFAB), directed by my pal, Professor Jeremy Ficca. Inspired by a tweet from Evan Roth, one of the co-creators of GML, we reckoned it would be easy to transcode GML into

Robotagger

a file format suitable for robotic CAD/CAM machining. The result is a small Processing utility that converts GML into DXF and CSV. After tinkering around for a while we developed a pipeline for converting the GML/DXF strokes from #000000book.com into machining paths for the dFAB's ABB IRB-4400, an eight foot tall industrial robot arm. One of our first tags, was made from GML produced by TEMPT1 (Tony Quan), a graffiti writer with Lou Gehrig's disease who produced the GML recording with the FAT Lab's well-known *EyeWriter* software. Although there's been a lot of data loss and translation along the way, it's not completely unreasonable to think of the *Robotagger* as a prosthesis for Tony. I hope we can pursue this possibility a little further. Speaking of future directions, there are lots of interesting research topics latent here in automated calligraphy. We were astonished to realize just how important the force-feedback of pressure is to the visual quality of the drawings. We shattered a marker and sent ink everywhere when our estimate of the Z-plane turned out to be off by a quarter-inch. Moreover, we're interested in exploring robotic performances of higher-dimensional gesture data, such as that produced by Wacom tablets, which provides high-resolution information about the pressure, azimuth and elevation (yaw and pitch) of the tagger's stylus. Watch this space – I'll be developing some tools to help the next version of GML encode this information.

The *Robotagger* is a collaboration of Jeremy Ficca's dFAB at CMU; the STUDIO for Creative Inquiry at Carnegie Mellon, which I direct; and the FAT Lab's GML initiative. We used the Sharpie Magnum and the wonderful 2-inch Montana Hardcore markers, which (AFAIK) are the largest magic markers in commercial production.



GML v1.0 Spec Doc

by Golan Levin, Evan Roth, Jérôme Saint-Clair, Chris Sugrue, Jamie Wilkinson and Theo Watson August 2010

<http://www.graffitimarkuplanguage.com/g-m-l-spec/>

```

<gml spec='1.0'>
<tag>
<header>
  <client>                                <!-- how, who, what and
where -->
    <name>Laser Tag</name>                <!-- application name -->
    <version>2.0</version>                <!-- application version
-->
    <username>MyUserName</username>      <!-- user name on
000000book.com, optional -->
    <permalink>http://000000book.com/data/156/</permalink>    <!--
URL to .gml data on 000000book.com, optional -->
    <keywords>katsu,paris,2010</keywords>    <!-- comma-separated -->
    <uniqueKey>28sks922ks992</uniqueKey>    <!-- iPhone uuid, MAC
address, etc -->
    <ip>192.168.1.1</ip>
    <time>1928372722</time>                <!-- unixtime -->
    <location>
      <lon>-39.392922</lon>
      <lat>53.29292</lat>
    </location>
  </client>

  <!-- This is all stuff that relates to the orientation and dimensions
of the client -->
  <!-- So that we know how to re-map the 0.0-1.0 coordinates that come
in for each point -->
  <!-- Also for figuring out the down vector for devices with
accelerometers and how that effects drips -->
  <!-- All numbers should be between 0.0 - 1.0 -->
  <environment>
    <offset>
      <x>0.0</x>
      <y>0.0</y>
      <z>0.0</z>
    </offset>
    <rotation>
      <x>0.0</x>
      <y>0.0</y>
      <z>0.0</z>
    </rotation>
    <up>
      <x>0.0</x>                            <!-- commonly up for iphone apps -->
      <y>-1.0</y>                            <!-- most common -->
      <z>0.0</z>
    </up>
    <screenBounds>                          <!-- use this as your multiplier to get 0.0 to
1.0 back to right size - pts should never go off 0.0 to 1.0 -->
      <x>1024</x>
      <y>768</y>
      <z>0</z>
    </screenBounds>
    <origin>
      <x>0</x>

```

GML v1.0 Spec Doc

```

        <y>0</y>
        <z>0</z>
    </origin>
    <realScale>    <!-- how these units relate to real world units -
good for laser tag -->
        <x>1000</x>
        <y>600</y>
        <z>0</z>
        <unit>cm</unit>
    </realScale>
    <audio>youraudio.mp3</audio>                <!-- path to
audio file -->
    <background>yourimage.jpg</background>    <!-- path to image
file -->
    </environment>

</header>

<drawing>
    <!-- for all stroke and movement stuff it helps to have everything
inside the stroke tag -->
    <!-- this way it is easy to get a sense of order to events -->

    <stroke isDrawing='false'>    <!-- for non drawing mouse movements -
->
        <pt>
            <x>0.0</x>
            <y>0.0</y>
            <z>0.0</z>                <!--this is optional -->
            <t>0.013</t>            <!-- time is optional too -->
                                     <!-- NOTE: older versions of GML
use <time> instead of <t> -->
        </pt>
    </stroke>

    <stroke>                <!-- by default stroke
drawing is true -->

    <!-- each stroke could be drawn with a different brush -->
    <!-- if no brush tag is found for a stroke then it inherits the
previous settings -->
    <brush>
        <mode>0</mode>    <!-- same as uniqueStyleID but an internal
reference -->
        <uniqueStyleID>LaserTagArrowLetters</uniqueStyleID> <!-- unique
blackbook string for your style -->
        <!-- see note about spec at the bottom - like unique style but
with extra info -->
        <spec>http://aurltodescribethbrushspec.com/someSpec.xml</spec>
        <width>10</width>
        <speedToWidthRatio>1.5</speedToWidthRatio>    <!-- put 0 for
fixed width -->
        <dripAmnt>1.0</dripAmnt>
        <dripSpeed>1.0</dripSpeed>
        <layerAbsolute>0</layerAbsolute>    <!--Think photoshop layers--
>

    <color>
        <r>255</r>
        <g>255</g>
        <b>255</b>

```

GML v1.0 Spec Doc

```

        <a>255</a>      <!-- optional -->
    </color>
    <dripVecRelativeToUp>      <!-- what angle do our drips go in
relation to our up vector -->
        <x>0</x>
        <y>1</y>
        <z>0</z>
    </dripVecRelativeToUp>
</brush>

    <pt>
        <x>0.0</x>
        <y>0.0</y>
        <z>0.0</z>
        <t>0.013</t>      <!-- this is optional -->
    </pt>      <!-- time is optional too -->

    <pt>
        <x>0.0</x>
        <y>0.0</y>
        <z>0.0</z>
        <t>0.023</t>      <!-- this is optional -->
    </pt>      <!-- time is optional too -->

</stroke>

<!-- this stroke inherits the previous stroke properties -->
<!-- but changes color and draws on the layer below -->
<stroke>
    <info>      <!-- optional info - more stuff soon-->
        <curved>true</curved>
    </info>
    <brush>
        <color>
            <r>255</r>
            <g>255</g>
            <b>0</b>
        </color>
        <layerRelative>      <!-- this means one layer below the
previous layer -->
            -1
        </layerRelative>
    </brush>

    <pt>
        <x>0.0</x>
        <y>0.0</y>
    </pt>

    <pt>
        <x>0.0</x>
        <y>0.0</y>
    </pt>

</stroke>

<stroke>
    <pt>
        <pres>0.5</pres>      <!-- Optional. Pressure range from 0 to 1 --
>

```

GML v1.0 Spec Doc

```
        <rot>0.5</rot>      <!-- Optional. Rotation range from 0 to 1 for
0 to 2*PI -->
        <dir>                <!-- Optional Direction -->
            <x></x>          <!-- range from 0 to 1 -->
            <y></y>          <!-- range from 0 to 1 -->
            <z></z>          <!-- Optional inside direction.
Range from 0 to 1 -->
        </dir>
        </pt>
    </stroke>
</drawing>

</tag>

</gml>
```

GML Recording Machine

by **Muharrem Yildirim** June 2011

<http://ffff.at/gml-recording-machine/>



GML (Graffiti Markup Language) Recording Machine is a DIY device that is capable of capturing and writing a spray can's movement to a microSD card. With two separate strings attached to each foot of the graffiti writer – writer needs to keep his/her feet still – (also can be attached to the wall, to keep the writer's feet free), position of the spray can is tracked during the tag writing process. These string's length are measured by a simple ball mouse where these strings turns the X and Y rollers inside the mouse and the strings are retracted by two retractable tape measures. These measurements are processed by an Arduino and stored in an SD card to be converted to GML later on.

This device can be constructed using and modifying everyday found materials such as:

- Arduino
- Arduino SD Shield
- Retractable tape measure x 2
- Ball mouse
- Strings
- Water tube to attach the spray can
- A nut and a bolt (to keep the can attached and adjust the height).

FAT Hoodies

by **Becky Stern** January 2010

<http://ffff.at/fat-hoodie/>

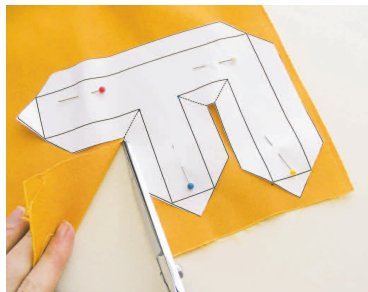
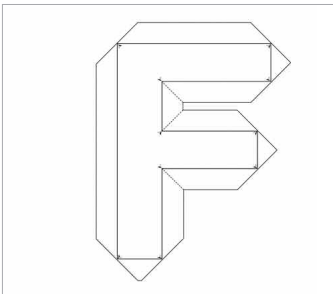

Materials: hoodie, fabric, needle & matching thread or fabric glue
Tools: scissors, iron, pins, printer, fabric marking, pen

1. Print and cut out pattern pieces
2. Pin to right side of fabric and mark corners of letters (arrows)
3. Cut around pattern (dotted lines are slits)
4. Fold over and press seam allowance to wrong side of fabric
5. Pin letters to hoodie
6. Sew letters to hoodie with a ladder stitch or glue to hoodie with fabric glue

Step-by-step instructions are available on *Instructables*:
www.instructables.com/id/FAT-Hoodie-Applique/

Lost and Found

Geraldine Juárez and Randy Sarafan [1]

Search

But, “what is Google?” she asked.

Google is a search engine and web giant. It is also a silly imaginary word. It can be used as a noun, adjective, verb, adverb or slur.

There is no other search engine quite as good as Google. You don’t believe me? Let me Google that for you. I Googled your name but didn’t find any avocado recipes. Stick that up your Google!

For you see, Google is not all that meets the eye. It is like an amulet, a talisman. You may use it to find everything. And Nothing. And then look at related pictures. What would you like to know? What do you need to know? What is it that you are looking for? Google can fulfill that desire.

In a social reality in which tangible interaction has been traded for virtual connectivity, Google is the largest broker of wish fulfillment.

Searching is not only a function of the system, it is the system.

Searching is the basis for all computing – superseding any operating system – created for you to experience an organized illusory reality.

Joining the greatest data cult ever imagined has but a few limitations.

Please consult Google’s Terms of Service for further details.

There are no blanket statements that one could say about Google.

It is vast like the cosmos and pervasive like the basic elements.

With its ability to index from the most pointless forms of creativity to the most current world altering events, Google can give the layman the impression that it is able to control everything. But What is Everything?

You can find the answer on Google. And once done, turn off “safe search” and look at related pictures. It is promised that none of the images are porn and only half contain lolcats.

You have just altered your search settings.

Everything can be advertising.

Nothing can be Internet search, e-mail, online mapping, office productivity, social networking, and video sharing And Viceversa. And then turn off “safe search” and look at the related pictures.

Search accurately with operators. Create a filter. Invite a friend. Turn off “safe search” and then Google your friends name. There is unlimited storage space for everyone and counting.

Google is an entity so pervasive on the internet, that half the time you do not even realize it is there, but it is necessary for you to remember it’s still there in various simple data forms:

- Alerts
- Analytics

Lost and Found

- App Engine
- Apps for Business
- Blogger
- Bookmarks
- Calendar
- Chrome Bookmarks
- Contacts
- Docs
- Finance
- Gmail
- Health
- iGoogle
- Google Googles
- Maps
- Notebook
- Orkut
- Picasa Web Albums
- Project Hosting
- Reader
- Sites
- Voice
- Web History
- YouTube

It is free and available like the air you breathe. It comes in an assortment of friendly colors and can be customized to your liking. It saves you time and energy. It can turn phone numbers into addresses and math problems into answers. It can bond the living and heal the sick.

Explore and Innovate

But “how did Google become everything” she asked?

Webring just didn't work. No matter how many webrings people made, you just could not surf there from here. There was always an outpost of “under construction” banners just over the horizon of socially mapped connectivity. This was unacceptable. Manifest destination determined that users should be able to get everywhere from anywhere. Information needed to be freed and shopping needed to be accessible. There could only ever be one pets.com.

Exoticpets.com, rarepets.com, rareexoticpets.com, rareexoticpetfood.com would all be outposts in the wilderness without a road to lead you there. Google's benevolent hands built that road. And they built millions of other roads. And then they lined these roads with billboards. And with the money they made on these billboards,

Lost and Found

they built entire cities of industry. And within these cities, they erected more billboards. And pretty soon, Google, the mere builder of roads, owned half of the frontier, which is no longer a frontier, but a megapolis without borders.

Privacy is overrated, therefore there is no need to protect it.

Censorship is necessary; we want to legitimize it.

Copyright infringement is a fantasy, we must all ignore it.

Google is not a religion. It is the framework of social order. Atop of Google sits the faith of a disjointed society feverishly dependent on the continual flow of virtual commodities. As the internet turns into a generic planned community of manicured tract housing, Google is the pavement that leads to the gates. Everyone is welcome to enter. We speak any language. We index any type of information. We have unlimited space for you and your data, regardless of its excesses. We will connect you to anyone at any time.

Communicate, Show & Share

“I can’t remember clearly when i signed up though”, she recalls.
“Although, I think I was invited by a friend.”

During these years she has been having trouble figuring out if Google is branded. They seem so stupid naive sometimes that is hard to difference between branding or genuine nerdness. Since according to the world, everything is a brand, probably the silly font and simple colors are just another way to pervasive control. Unless you say our name too much. If we become fully integrated into the culture, we lose the right to our trademark. Our direct control over your engagement with the internet is contingent upon our brand retaining the appearance of not being pervasive in your life. Do not be mistaken. We want to be pervasive in your life, but we have no desire to relinquish control of our trademark, brand, identity or cultural philosophy. Stop talking about us. Keep searching.

What if Google is really a nerd that is sort of cool? – she asks her self sometimes.

But wait... Then, why Google will go on a cyberwar with China?

Because you can’t mess around with Google.

Please read carefully these guidelines:

Things You Can’t Do

- One of the conditions for all uses is that you can’t mess around with our marks. Only we get to do that. Don’t remove, distort or alter any element of a Google Brand Feature. This will totally mess up the Google

Lost and Found

Brand Image. Seriously. Don't modify a Google trademark or everyone will be totally bummed out. We don't think it's funny when you say things like Googliscious, Googlyoogly, GaGooglemania. Nor do we think its funny when you shorten, abbreviate, or create acronyms out of Google trademarks. In fact, we would prefer if you simply never talked about Google. I know that we are, like, totally a part of culture at large, but please refrain from generalizing our trademark.

- Don't display a Google Brand Feature as the most prominent element on your web page. Unlike us, your cafeteria is not catered well-enough to justify this.
- Don't display a Google Brand Feature in any manner that implies, suggests, hints at, or forces a relationship or affiliation with, sponsorship, or endorsement by Google, or that can be reasonably interpreted to suggest editorial content has been authored by, or represents the views or opinions of Google or Google personnel. Google doesn't like anything and Google surely doesn't endorse anything. Google only endorses itself.
- Don't display a Google Brand Feature on any web site that contains or displays adult content, promotes gambling, involves the sale of tobacco or alcohol to persons under twenty-one years of age, or otherwise violates applicable law. Google reserves the explicit right to engage in this activity. It is Google's goal to index and exclusively promote all material that someone may encounter in Las Vegas.
- Don't display a Google Brand Feature in any manner. In our opinion, Google reserves the sole right to be misleading, unfair, defamatory, infringing, libelous, disparaging, obscene or otherwise objectionable.
- Don't try to censor anything. We reserve all rights to do so. Wether you are the largest country on earth, a humanitarian NGO, a Russian hacker conglomerate or rival website, we reserve the right to silence you.
- Don't display a Google Brand Feature on a site that violates any law or regulation. This includes the laws of physics and is not constrained by poor health code scores. Google can not be responsible for eating establishments that violate local health code laws, including the use of hairnets and allowance of small animals into the eating establishment.
- Don't frame any mirrors without a certified Google feng shui life-coach. We suggest consulting with our legal department before undertaking any home redecoration projects.
- Don't incorporate Google Brand Features into your own product name featured brand, service brand name features, trademarked logos, or company brand name trademarks, until death do we part. The Google Brand Name Feature Logo is the sole proprietary

Lost and Found

property of the Google Brand Company Trademarked Trademark.

- Don't copy or imitate Google's trade dress. This includes party dresses, cocktail dresses, mini dresses, gowns, skirts and various colored halter tops. Google has the look and feel of today's youth. Google brand packaging, distinctive color combinations, typography, graphic designs, product icons, and imagery have nothing to do with how good we look. Damn we're fine!
- Don't adopt marks, logos, slogans, or designs that are confusingly similar to our Brand Features unless you are part of an art collective telling us to go FUCK ourselves.
- Don't register with Google web pages.
- Don't use Google trademarks in a way that suggests a common, descriptive, or generic meaning. Like we said earlier, don't talk about Google. Google is specific to Google. Google is specific to Google. Google is Google is Google. Stop saying Google! Stop making us generic! All our trademarks are belong to us!
- Trademark rights vary from country to country. Some countries have severe criminal and civil penalties, but we wish that they all would. We are mapping your neighborhoods with our camera vans and we are recording your movements. We know where you eat and we know about your health concerns. We know where you log on to the internet and we know what type of pornography you like masturbating to and how you have been looking at more pornography since your wife left you. We know you like looking at the related pictures. We know all about you. You better think twice before you talk about Google. Only Google may talk about Google. Google is specific to Google. Google is us. We are Google. We reserve all the rights to reserve you none. Shut up and look at the related pictures. We indexed them just for you.
- Do not dare to hack us. We will bring you down. Do not try to innovate more than us. We will buy you out.

If there is any question about usage, please keep them to yourself. Requests for clarification or permission may be subject to harsh punishment. Have you not just read the list of things you can't do? Seriously.

Go Mobile

Google has a compound in Mountain View. It is called the Googleplex. In 199___ they distributed razor scooters to all of their employees. This resulted some months later in middle aged soccer moms breaking their wrists on walking trails in Florida. Let me Google that for you and look at the related pictures.

The Googleplex has a twisty slide and a well-stocked snack bar. It is

Lost and Found

abuzz with the best and the brightest. They work at optimizing your optimization.

Aside from frivolous children's toys, Google invests in other things. They invest in server racks ___ amount of computing ___ they invest in alternative energy initiatives to compensate for the egregious power consumption ___ they invest in spy Satellites, well because if you had the money, wouldn't you? They invest in failing startups like ___ and thriving startups like ____. Google is the muscle behind Youtube and at one point was the brain behind ___ Google is the energy that drives information such as ____ A picture can say more than a thousand words like __ Google Googles disintegrates typing and words, look ____ Just take a picture to search ____ Your pictures, our control. Turn on "visual search history" to view or share your pictures at any time. Turn it off to discard them once the search is done. We keep the whole track of it for us.

Google has the legal standing of a single individual, but employs hundreds, if not thousands of people. Some of them know each other. Most of them do not. They work together towards a common goal. Do no evil. See no evil. Hear no evil. Index everything blindly. If we don't see it, it's not there. DMCA is the name of the game. Don't ask. Don't tell. We are infringing copyright law? Who, us? Just tell us where and how, we will fix it. Unfortunately, we do not police our content. DMCA! DMCA! Don't look this way!

Notes

[1] This essay was originally written in February 2010, on the occasion of F.A.T. Lab participation in Transmediale 2010, Berlin.

Fuck Google

February 2010

<http://ffff.at/fuck-google/>

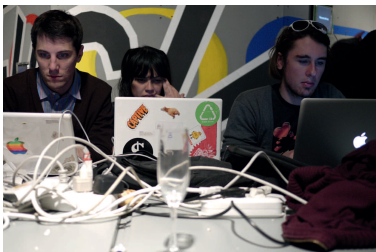

Fuck Google

In February 2010, F.A.T. Lab was nominated for the Transmediale Award 2010, and invited to take part in the festival, that took place from February 2 to 7 in Berlin. For the occasion, they decided to focus on Google and to launch a “Fuck Google Week” that produced a number of notable projects. As they wrote in the festival’s catalogue:

“Google is the most popular site on the world wide web. Since Larry Page and Sergey Brin opened the Menlo Park doors of their corporate office in 1998, Google has grown to be much more than just the defacto information search utility for the web. Beyond having over 150 domains, dozens of web, browser and desktop apps, a number of the most popular sites on the web (like YouTube), partnerships with multimedia conglomerates and multinational telecoms, one spy satellite and a mysterious network of telecommunication infrastructure, Google has become a new word in the international lexicon. I Googled it. 구글했다. Je l’ai googlelé. Jeg googledede det. ググった Eu Googled isso. Ich hab’s gegoogled. मैं googled है. Yo googleo. Google, Ergo Sum.

But, it wasn’t always easy streets for the kindly, corporate giant. Shining a light into the darkness of the early web was not as simple as it looked. It took patience, a “don’t be evil” mantra, football fields of high-end office furniture, and millions and millions of ads [...]

So, what is so “fuck-worthy” about Mother-google? It is the fact that a corporate entity, even one as beloved and competent as Google, is in control of such a large stake in the digital network and public utility upon which we have all grown so reliant. And, that as a publicly traded company, it doesn’t have to answer to anyone but its largest shareholders, despite the fact that its decisions effect the lives and private information of millions of people. Few even question or raise a voice in opposition to the Google-ification of the Internet. Don’t get us wrong, we use Google too. We use search, blog search, gmail, YouTube, calendar, docs, analytics, maps, etc. We use them like we do the sidewalk or a public toilets when we have to take a piss: because it feels like there just isn’t any other option. Sure, there are alternatives to Google. But, they mostly suck. And to not use Google means to lose access to an enormous network and some of the most reliable tools on the Internet. That is why for Transmediale 2010, F.A.T. Lab proposes ‘FuckGoogle’, a collection of browser add-ons, open source software, theoretical musings and direct actions aimed at creating an awareness of the role Google plays in our daily lives. Throughout the duration of Transmediale, F.A.T. members and friends will publish free software, live streams, communiques and video documentation of actions on the fffff.at blog. So, join us and let’s all FuckGoogle together. By the way, does anyone have Sergey’s email or home address?”

Are you evil?

by Aram Bartholl February 2010

<http://ffff.at/are-you-evil/>



How many Google services do you use? *Are you evil?* is a t-shirt featuring check buttons for all the services provided by Google. Once you have it, you can customize it by checking the ones you use. The project is based on Aram Bartholl's previous work *Are you social?* (2007), a t-shirt featuring check buttons for the most used social networking services. They were both inspired by Markus Angermeier a.k.a. Kosmar series of "micro buttons", originally to be displayed on websites.

The printable version is available here:
www.ffff.at/fuckflickr/data/are-you-evil/are-you-evil-T-shirtprint%20copy.png

Fuck Google Pins

by **Geraldine Juárez** February 2010

<http://ffff.at/fuck-google-pins/>



Fuck Google, it's your data. During Transmediale 2010, Geraldine Juárez designed and printed some customizable pins.

Participants could take them and hand-draw on them.

The original design is still available for download here:

<http://ffff.at/files/2010/02/buttons.pdf>

Fuck Picasa

by **Geraldine Juárez** February 2010

<http://ffff.at/fuckPicasa/>



Fuck Picasa is a customized version of Geraldine Juárez's former work *Kopyfamo'* (2009).

The web page allows you to apply customized logos on an image you choose and to upload it to F.A.T.'s FuckFlickr online gallery.

fuckCAPTCHA

by **Greg Leuch** February 2010

<http://ffff.at/fuckcaptcha/>



reCAPTCHA is a user-dialogue system originally developed at Carnegie Mellon University's main Pittsburgh campus, and acquired by Google in September 2009. reCAPTCHA asks users to enter words seen in distorted text images that optical character recognition (OCR) software has been unable to read. By presenting two words it both protects websites from bots attempting to access restricted areas and helps digitize the text of books.

The founder of reCAPTCHA created their tool to prevent spam and help humanize OCR scanning errors, later noting that he had "unwittingly created a system that was frittering away, in ten-second increments, millions of hours of a most precious resource: human brain cycles." Google bought reCAPTCHA assumingly to help with the work of their book scanning project. So, Leuch asks, why should you help them? You shouldn't.

fuckCAPTCHA is an open-source alternative to the spam prevention and evil humanization of human brain cycles for corporate pet projects. It was written on the same principle of reCAPTCHA, but focused on enforcing the "fuck corporate culture". Any website owner can add the *fuckCAPTCHA* plugin to their website and have their visitors affirm the fuck corporate culture by entering in the "fuck google" confirmation text.

To add *fuckCAPTCHA* to your website, just copy and past in your code the text below:

```
<script type="text/javascript"
src="http://ffff.at/widgets/fuckCAPTCHA/fuckCAPTCHA.js"></script><sc
ript type="text/javascript">if (FATLab_fuckCAPTCHA)
{FATLab_fuckCAPTCHA.Values.Theme='default';
FATLab_fuckCAPTCHA.Make();}</script>
```



Dr. Google

by Greg Leuch February 2010

http://fffff.at/dr-google/

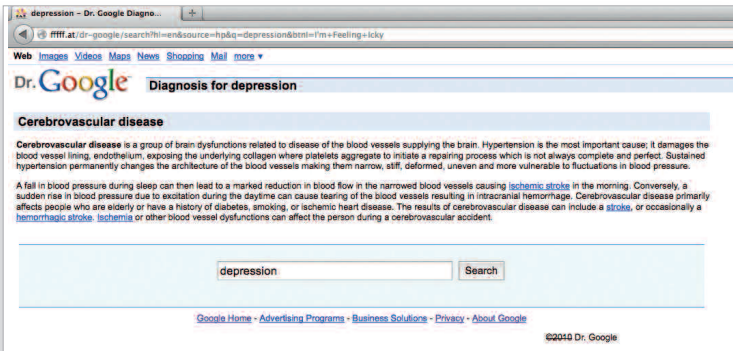

Feeling sick? Not sure what you’ve come down with? Let Google diagnose you! Enter your symptoms into the search box, and press “I’m Feeling Icky” to be diagnosed. Don’t like your options? Go back and get a “Second Opinion”.

On October 2, 2013, F.A.T. Lab received a “cease and desist” letter from Google, asking to take down *Dr. Google* from the web. By the time of the publication of this book, the project might not be online anymore. We hope you enjoyed *Dr. Google’s* diagnoses for the three years of its existence.



The Fake Google Street View Car

by **F.A.T. Lab** February 2010

<http://ffff.at/google-street-view-car/>

One of the most memorable results of the “Fuck Google Week” at Transmediale 2010 was the fake Google Street View car that F.A.T. Lab was able to build and send out in Berlin.

This came at a time when Google was introducing Google Street View in Germany, generating a lot of criticism and stimulating much debate on privacy issues.

The Fake Google Street View Car was a non-functional replica of the actual Google Street View car, made using the car model chosen by Google to scan streets in Germany, and mounting a DIY but faithful replica of the nine-eyed camera on its top. Then F.A.T. Lab members started driving the car in the streets of Berlin, sending its GPS coordinates to a map available on their website.

The project made headlines in international media as some journalists actually believed the hoax according to which F.A.T. Lab was able to place a GPS transmitter on a real Google car and make its current positioning publicly available online, so that people in the streets could check it and manifest their criticism in front of the car itself. This is what *The Guardian* wrote on February 8, 2010: “[...] a team of German artist-pranksters – the self-assigned Free Art & Technology group – has done rather better: while the Street View car was idling outside their offices, they nipped over and attached a GPS device to it.

The result: for a while on Sunday you could see in real time just where it was, and the group also generated a map showing where it had been [...] Much hilarity ensued, although Google obviously got wise to it and seem to have removed it.” Soon came Google’s retraction: “Just saw your piece on the GPS Street View car in Germany and wanted to let you know it was a hoax :-).”

Free Art and Technology (F.A.T.) Lab is an art organization which recently used a fake Street View car as an art project in Berlin and claimed to have put a GPS tracking device on in to track its route.

This car was not an official Google car, as we are currently not driving through Germany as there are not optimal weather and light conditions at this time of year.” Other media that reported the news were *Forbes*, *NBC Bay Area*, *Tech Crunch*, *Boing Boing* and the *Huffington Post* among many others.

A few days later, Aram Bartholl made the following instructional on “How to Build a Fake Google Street View Car” available on the F.A.T. website:

The Fake Google Street View Car

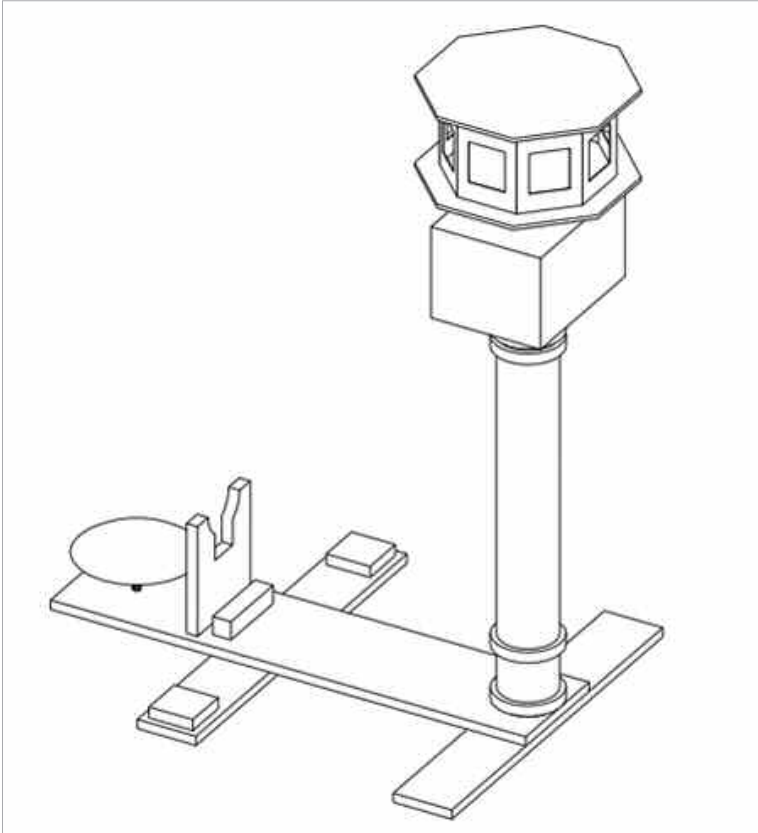

Step 1: Find the correct car:

Do some research on Google images and pick the exact car model used by Google in your city. Contact your local car rental. If the car doesn't come with one, rent or buy the specific roof-rack for that car.



The Fake Google Street View Car

Step 2: Materials:

- (x1) PVC tubing 11 cm diam. – 140 cm (main pole)
- (x2) wooden boards 100 x 16 x 2,5 cm (base)
- (x1) wooden board 130 x 30 x 2,5 cm (base)
- (x2) wooden poles 3 cm diam. – 130 cm (diagonals)
- (x2) wooden poles 2 cm diam. – 100 cm (lower diagonals)
- (x2) wooden board 55 x 55 x 1 cm (octagon)
- (x2) wooden board 40 x 30 x 1 cm (center box)
- (x2) wooden board 40 x 23 x 1 cm (center box)
- (x2) wooden board 28 x 230 x 1 cm (center box)
- (x6) big sheets of 2mm card board(x16) L-brackets
- (x1) container craft glue
- (x1) hot glue gun
- (x1) roll of double-sided tape
- (x1) 50 meter roll of white duct tape
- (x1) can of black paint
- (x1) paint brush
- (x3) black spray paint
- (x2) white spray paint
- (x1) big sheet of black reflective vinyl
- (x10) M8 x 50 bolts
- (x10) M8 nuts
- (x50) selection of wood screws
- (8 m) steel cable
- (x8) cable crimps
- (x4) cable tensioners
- (x8) eye hooks
- (x2) Google street view signs
- (x1) roof rack

Step 3: Plan overview:

Feel free to make adjustments to the dimensions and go into more detail than we did. As you can see, our camera-top came out a little bigger than the original one. The laser scanners (white boxes) were adjusted to size but came out too big in relation to the rest.

The Fake Google Street View Car

Step 4: Center box & tube

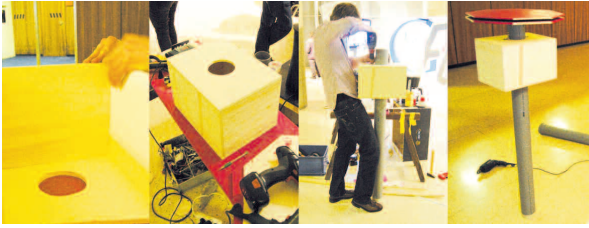

Cut the inner and outer octagon walls from the cardboard.
Paint both sides of the strips black.
Glue 4 pieces of wood (23 cm) to the inner ring.

Screw and glue the inner ring on the base.
Hide the inside with a cylinder of black vinyl.
Screw and glue the top octagon.
Clamp the outer ring on.
Mount the finished octagon on the main tube with L-brackets.

Step 5: Octagon (no cameras inside!)



Cut the inner and outer octagon walls from the cardboard.
Paint both sides of the strips black.
Glue 4 pieces of wood (23 cm) to the inner ring.
Screw and glue the inner

ring on the base.
Hide the inside with a cylinder of black vinyl.
Screw and glue the top octagon.
Clamp the outer ring on.
Mount the finished octagon on the main tube with L-brackets.

Step 6: Laser scanners & control unit



Build the laser scanner boxes from cardboard.
Use white tape or paint to cover them.
Bend a piece of cardboard in the window and cover it with black vinyl.

Mount the 3 boxes to the center box (directions!)
Build the control unit, paint it yellow, and screw it to the rear side of the center box.

The Fake Google Street View Car

Step 7: Mount main pole on base unit



Mount the main pole to the base with L-brackets.

Attach rods to the ring on the tube and screw them in the base.

Stabilize with flight

cables on all 4 corners of the center box to the base.

Add lower diagonals, dish and stand for optical enhancement.

Step 8: Mount the fake camera top onto the car:



Screw 4 holes (8mm in diameter) in each bar of the roof rack.

Drill the corresponding holes in the wooden base.

Mount the camera top with nuts and bolts to the roof rack

Make sure the roof rack is mounted and sits tight.

Drive carefully and have fun in the city!!!



Gcar Tracker

by **Greg Leuch** February 2010

<http://fffff.at/how-to-track-the-google-street-view-car/>

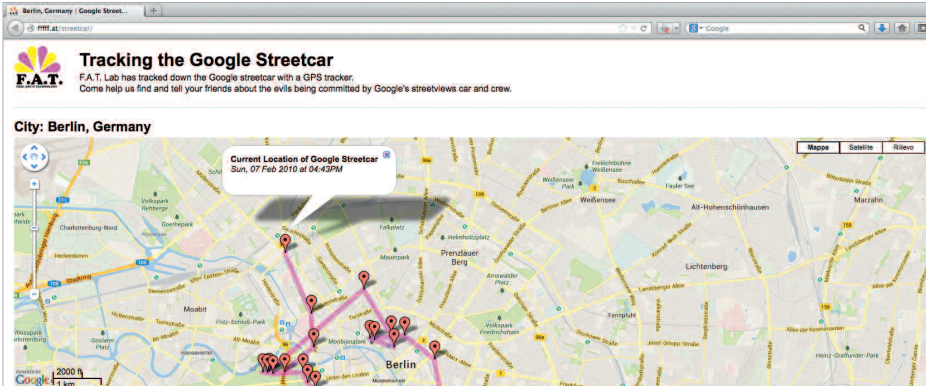

GCAR Tracker is a Twitter app that allows you to track GPS coordinates from a Twitter account onto a map. It was used by F.A.T. Lab for the Google Streetview Car Berlin prank. Once connected to a given Twitter account, the app can be used from a GPS enabled smartphone to send coordinates to a map. In Berlin it was used to send data from the fake Google Street View car to streetcar.fffff.at, making the prank more plausible and thus cheating media outlets.

The code is still available on *Github*, at <https://github.com/gleuch/gcar-tracker>.

Once you have installed the app:

1. Get inside a Google Street View Car.
2. Open your favorite Twitter app on GPS enabled smartphone.
3. Tweet sporadically to plot geographic points on the map.
4. Relax as the blogosphere and media outlets go into a frenzy.

Google Alarm

by **Jamie Wilkinson** July 2010

<http://fffff.at/google-alarm/>



The *Google Alarm* Firefox addon visually & audibly alerts you when your personal information is being sent to Google servers. Even outside Gmail and YouTube you are constantly sending information to Google through their vast network of tracking bugs: Google Analytics, Google AdSense, YouTube embeds, API calls... All of these data can be used to monitor & track your personal web browsing habits. *Google Alarm* shows notifications, plays sound effects and keeps running stats about the % of websites you have visited with Google bugs present. Stay alert – install *Google Alarm* today. *Google Alarm* was developed by Jamie Wilkinson during FAT Lab’s “FUCK GOOGLE” week in Berlin, Germany during transmediale 2010. Thanks to Evan Roth, Tobias Leingruber and Aram Bartholl for advice & assistance.

How to Tweet Porn

by **Randy Sarafan** February 2010

<http://fffff.at/how-to-tweet-porn/>

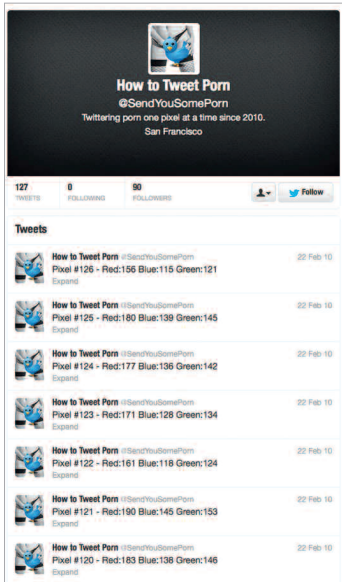

The popularity of Twitter's real-time publication platform has very rapidly transformed a data-rich communication medium (Teh Internetz) into a rapid-firing, text-based, publication tool akin to a high-tech telegraph. While on one hand it is useful to have a massive database of real-time, localized, data-sets, consisting primarily of useless social drivel, on the other hand it has yet to be effectively demonstrated as to why. The worst of it is that Twitter's posting restrictions have limited the communications of countless seemingly intelligent and talented individuals to a level of mental impairment and has also obscenely limited their ability to meaningfully express themselves and/or engage in sustained critical dialogue.

And let us take a moment as not to forget that pervasive digital publishing services don't just operate on electronic devices, but also drive the future development of said devices. The proliferation of Twitter will have a serious impact upon the future development of devices intended for real-time networked communications by undermining the value of a rich multimedia experience. This will limit the ability for mobile devices to share and publish images, audio and video. Most obvious, this will prevent the dissemination of the art form that prior to now unequivocally set technological standards – pornography.

How to Tweet Porn

Until recently, Twitter's unique platform has made it nearly impossible to engage in real-time transmission of pornographic images, setting technological advancement back decades. Yet, thanks to my own personal research and the development time of myself and known-pornovator Evan Harper, I present to you a methodology for using Twitter's stunted interface for sharing data-rich pornography, one pixel at a time. It is my hope that this will further the development of integrated data-rich content within Twitter's unique platform. Perhaps some day, the medium will advance to the point where we will be able to use Twitter to transmit girl-on-girl video in semaphore.

Follow Porn on Twitter!

<http://twitter.com/sendyousomeporn>

Follows are detailed instructions for you to share pornography in real-time, pixel by pixel, with your friends and family. Complete instructions with download links are available on *Instructables*:
www.instructables.com/id/How-to-Tweet-Porn.

Step 1: Go get stuff

To get started you will need:

- An Apple computer
- A Twitter account

Step 2: Download some files

If you are using OS X 10.4 or greater download "Porn to Pixels v.2.0 compiled". If you are using any other operating system download the source and figure it out.

Step 3: Tastefully acquire pornography

Finding pornography on the internet is easier than you might think! All you need is a standard web browser and some old-fashioned know-how. Open your web browser and go to a site called Google.com. Click on the link at the top of the site where it says "images" to access Google Image Search. On the Image search page select "advanced image search." Now, towards the bottom of the page there should be a menu item called "Safe Search." Toggle "Safe Search" to no "No Filtering" and click the "save" button. You should now be all set to find pornography on the internet.

All you need to do now is to return to the main Image Search page and type into the search bar the first name of any female in the western

How to Tweet Porn

hemisphere and hit enter. This will load up a host of pornographic images for you to share. For instance, try typing in the names of some of your friends like “Lisa,” “Anne” or even “Marie” (especially Marie!). Remember that time you had a waitress named “Simone?” Try typing that in! Wow! Look how easy it is to find pornography.

Once you have found some pornography, make certain it complies with all federal laws (such as US Code Title 18, 2257 in regards to proper record-keeping), and that you have permission to share it. After you are sure the image matches these criteria, right-click to save it to your computer.

Tip: To comply with normal pornography indexing standards, I recommend organizing your pornography in folders categorized by number of participants, ethnic origin, height, hair color and act(s) being performed.

Step 4: Begin tweeting pornography

Open your “Porn to Pixels” application and enter your username and password.

Click the load image button and select the image you would like to send.

To begin the process, simply click “Tweet Next Pixel.”

From here on out, it will continue tweeting pixels until it reaches the end of the image. All you have to do is open the application and it will pick up wherever it left off the last time you had it open.

Step 5: Automate

Hold down on the program icon in the dock and select the option “Open at Login.”

You will now be all set to start tweeting porn as soon as you log into your computer.

Auto Smiley

by Theo Watson March 2010

<http://fffff.at/auto-smiley/>

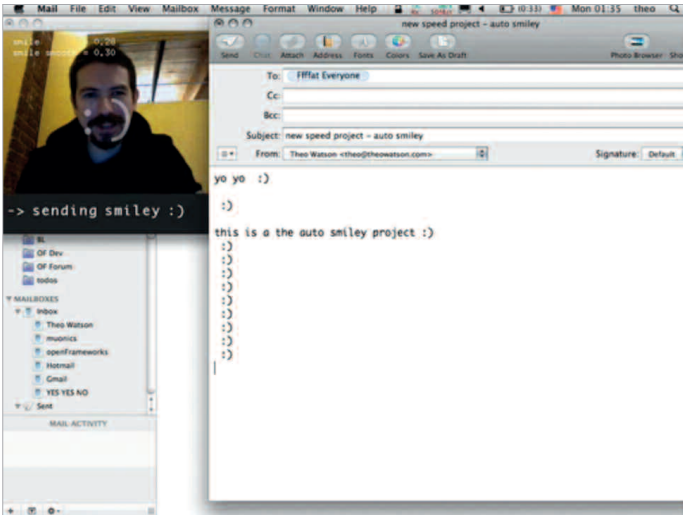

Auto Smiley is a computer vision application that runs in the background while you work. The software analyzes your face while you are working and if it detects a smile it sends the ASCII smiley face letters “: :)” as keyboard presses to the front most application.

Auto Smiley has many uses from just straight up convenience to enforcing honesty in your online communication :)

The project uses openFrameworks and The Machine Perception Toolbox (MPT) for smile detection. It’s available for PC and Mac OS.



Twitter Fileshare

by **Greg Leuch and Theo Watson** April 2010

<http://ffff.at/twitter-fileshare-or-how-to-tweet-any-file-on-twitter/>



Governments and private organizations continue to lock down legitimate file sharing through raids, law suits, and “consumer protection” laws & treaties. And while larger file sharing arenas are targeted, many forget file sharing has existed across many different mediums for decades. Early filesharing beginning with Usenet groups, where the binary data was converted to text characters and reprocessed for download. Facsimile machines follow a similar method of dissemination of binary data. And even ham radio [1] used teletype to transmit photos across long distances by converting photos to ASCII before transmission.

Today, we have advanced systems built for sharing files: websites, FTP, BitTorrent, email, CD/DVDs, hard drives. We also have many systems today that mirror prior technology of Usenet newsgroups, paging devices, IRC chat rooms, and IM status messages, of which the largest modern equivalent today is Twitter.

If Twitter is today’s Usenet and Usenet was used for file sharing years ago, why shouldn’t Twitter be utilized today for file sharing?

Twitter Fileshare (originally located at <http://tweetfil.es>) was an attempt to seed movies, images, code, and other items of copyright or intellectual property on Twitter.

The project is not running anymore, but the code is still available on Github for further development: <https://github.com/gleuch/twitter-fileshare>.

Notes

- [1] “Amateur radio (also called ham radio) is the use of designated radio frequency spectra for purposes of private recreation, non-commercial exchange of messages, wireless experimentation, self-training, and emergency communication.”
From *Wikipedia*, http://en.wikipedia.org/wiki/Amateur_radio.

Catch a Cockerfly

by Randy Sarafan April 2010

<http://ffff.at/catch-a-cockerfly/>



A cockerfly is a member of the insect family that is best described as a cross between a cockroach and a butterfly. Its official species name is *Noahivius Weinsteinicus*. This name was derived by adding a whole bunch of Latin-sounding things to the name of its initial discoverer, Noah Weinstein. Very few living specimens of the cockerfly are known to exist. As such, very little information is available about the insect. One thing that us scientists know for certain is that while the standard cockerfly can withstand large doses of nuclear radiation, they are extremely fragile creatures and are brittle to human touch.

The cockerfly's natural predator is the domesticated cat. Predation accounts for their low population numbers as cockerflies are only found in highly urbanized areas populated by abnormal amounts of domesticated cats. Unsuccessful efforts have been taken to increase their population numbers by breeding them in captivity. Despite their best efforts, scientists were unable to set the mood to encourage mating amongst cockerflies. Scientists' spouses were not surprised.

On account of people's love of cats, and scientists always showing up to ruin the mood, it is likely that the cockerfly may go extinct in our lifetime. They are currently on the list of endangered species. In spite of rapidly dwindling populations, very few people are upset. Considering that the continuation of the species is pretty much a lost cause, follows are instructions on how to help accelerate the extinction of the cockerfly through the acquisition and preservation of your very own specimen.

Step 1: Go get stuff

You will need:

- A scalpel
- Tweezers
- Dental picks
- #2 insect pins
- A sealable jar
- A refrigerator
- A roach problem

Catch a Cockerfly

A dead butterfly

Krazy Glue

A cardboard surface

The ability to hold your breath

(note: this will not work if you own a domesticated cat)

Step 2: Acquire a cockroach

Before you can preserve a cockerfly, you will need to acquire a garden variety cockroach to use as reference. Cockroaches can easily be found in offices located above restaurants and any apartment in Manhattan.

Catch an adult cockroach and place it in a sealable container.

For this I used an empty salt shaker.

Step 3: Euthanize the cockroach



Kill the cockroach by placing it in the freezer.

After two to three hours in the freezer, it should be good and dead. Take it out of the freezer and remove the cockroach from the container. Be careful handling it as not to damage it.

(Note: Dr. G says you should always wash your hands after handling cockroaches as they have

been known to cause allergies.)

I covered the holes on the top of the salt shaker with a piece of painters tape after concern was raised about placing a cockroach in the freezer with a container that had holes in it. I highly recommend a fully sealable container to circumvent this problem.

Step 4: Pin the roach



Pin the roach to your piece of cardboard such that it is held firmly in place (and if it accidentally wakes from the dead, it's not going to go anywhere). An ideal place to pin it is through the center of its body, just below its head. Be careful not to pin through its wings.

Step 5: Free the wings

Foremost, never touch a butterfly wings with your hands. It removes the coloration. Secondly, butterflies are very fragile. If you can avoid handling it by its wings, please do. Always use tweezers and dental picks to handle

Catch a Cockerfly



a butterfly. That said, pin your butterfly down to the cardboard. Using your scalpel, cut the wings free from the thorax such that a relatively sizable piece of thorax is left connected to the wing (for the time being). Once both wings are free, remove as much of the remaining bits of the thorax as possible from the wing while leaving

just enough thorax in place to still be able to grasp it with tweezers.

An easy way to do this is to place pins around the perimeter of the wing at an angle, which acts to temporarily hold it in place while you cut.

Step 6: Attach the wings



Look left. Now, look right. When you are sure no one is looking, Krazy Glue the wings onto the body of the roach (below the roach's wings). This is a difficult, frustrating, and, at times, infuriating task. Fortunately, this Instructable is here to help. The first helpful thing you can do is place a pin into the cardboard near the body of the roach

and use this to hold the roach's wing back so that you can easily glue the butterfly wing underneath. It also helps to have two pairs of tweezers for positioning the butterfly wing just right without using your hands.

Most importantly, it helps not to breathe. Seriously folks, don't breathe. You will notice that exhaling will almost assuredly move the butterfly wing (which, as per the butterfly effect, will ultimately cause an unwanted pregnancy in Cincinnati and ruin the Prom for everyone).

What worked for me was to take in a deep breath and position the wing as best I could during that time. When I couldn't hold my breath any longer, I would then turn my head completely to the side and exhale. I just kept repeating this process until I was done. Easy as that. Lastly, if the nozzle from the Krazy Glue is too large for you to work with, try applying a small amount to the tip of an insect pin and using the pin to apply the glue.

Step 7: Proudly Display



Once the glue is dry, display your cockerfly as you see fit.

As you can see below, I recreated a typical cockerfly scene.

Shaved Bieber

by **Greg Leuch** May 2010

<http://ffff.at/shaved-bieber/>

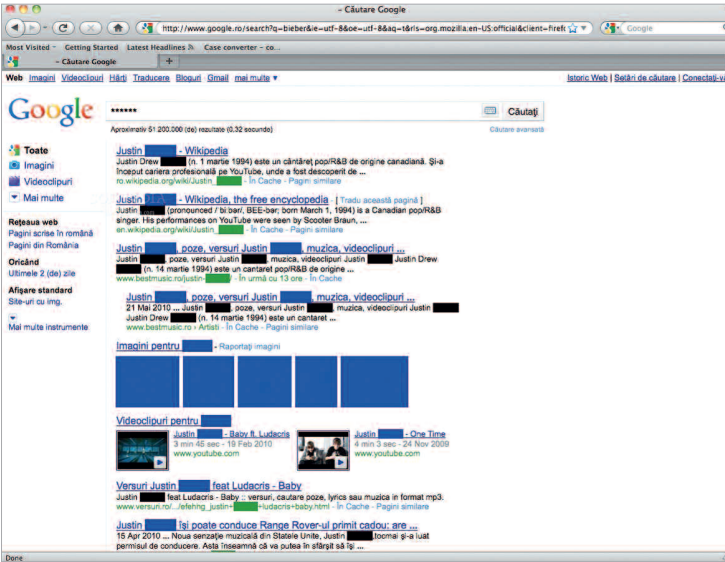

Shaved Bieber

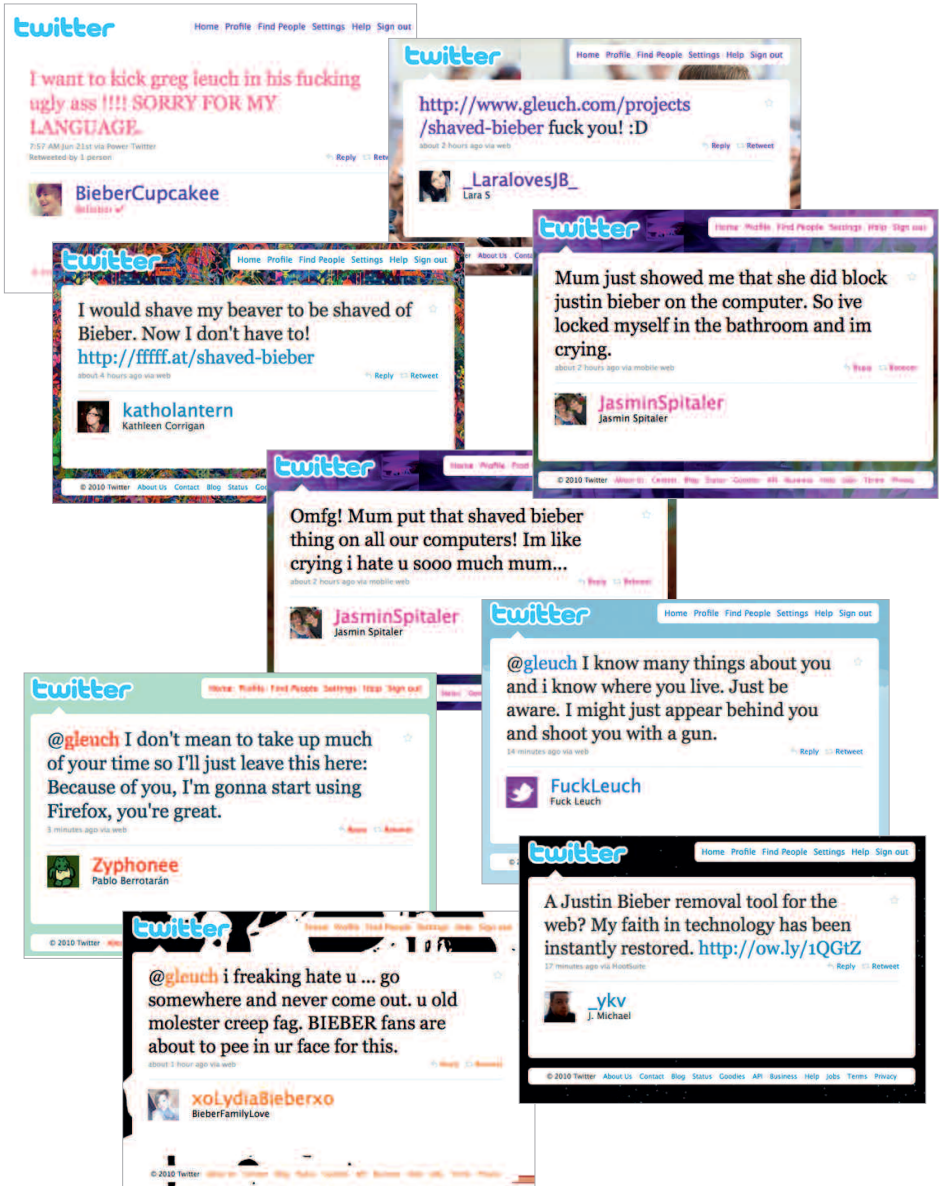

Shaved Bieber is a JavaScript project converted into a browser bookmarklet and Firefox Add-on. This project, capitalizing on the success of *Ctrl+F'd*, aims to provide tools to consumers to control, adapt, and modify the contents of the internet from their browser, allowing individuals to hide content they choose not to see. Personal censorship is an emerging idea in response to government

Shaved Bieber

and business censorship; an approach to providing a free, open, and neutral web that can still be censored by the individual. This piece began as a simple idea and spurned a public outcry of polar views on technology, pop culture, and online messaging mediums. In two weeks time, the popularity of this piece garnered over 100,000 video views, 85,000 blog views, hundreds of comments, multiple press mentions, and tens of thousands of tweets.

After the piece began to grow in popularity, the hate mail and fan mail began to pour in through comments, tweets, and emails.

Documentation of fan mail became important dialogical reminder of the effects of censorship, and the Tumblr blog <shavedbieber.tumblr.com> was created for this documentation effort, from the accolades to the death threats.

After *Shaved Bieber*, Greg Leuch released for F.A.T. other popular blockers, including *China Web Boycott* (May 2011), conceived as a response to Ai Weiwei detention, that prevents the user from surfing into Chinese web territories; *Dash-Out, the Kardashian Blocker* (November 2011), made when celebrity Kim Kardashian's marriage filled up gossip news with its gorgeous ceremony, romantic honeymoon, million dollar licensing fees, and everything in between; and *Olwimpics, the Olympics Blocker* (July 2012), a colorful blocker that during the Olympic Games allowed web users little interested in athletics to protect themselves from Olympics related content censoring it with fields and strips that randomly used the Olympics logo colors (blue, black, red, yellow and green).

More recently, this interest in personal censorship produced the "meta application" *Pop Block*, a tool that wants to help users manage their content bubble, by allowing them to control content visibility while browsing the web. Blocking and altering content is notably achieved through advertising blocking extensions, but the everyday web content we consume contains many more things we may wish to see or not see.

By launching a customizable keyword management service, *Pop Block* gives users the ability to control their engagement with content while browsing by highlighting or blocking content. This approach allows users to manage a list of keywords that synchronize wherever they have installed the extension.

Pop Block can be found online at <pop-block.com>, and is available for Firefox, Chrome, Safari and (even) Internet Explorer.

**LM4K
Unauthorized Research Fellow**

LM4K (short for Love Monkey 4000) is Michael Auger.

The editor hopes you don't need more info, because he didn't find any on Google.

<http://lm4k.com/>

FFFFFAT Turntables

by **LM4K** January 2011

<http://fffff.at/make-your-turntables-fffffat/>

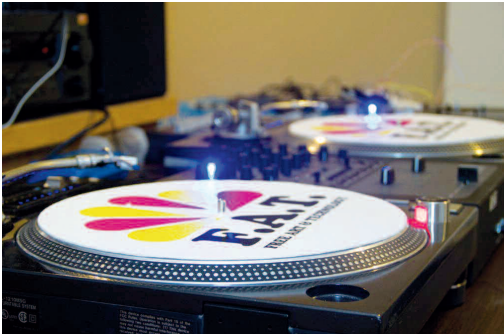

Lack talent? At least your gear can be FFFFFAT! These custom F.A.T. Lab slipmats are guaranteed to add +3 steeze points!

The Clap-Off Bra

by Randy Sarafan February 2011

<http://ffff.at/the-clap-off-bra/>



The first time I read about Syrian Lingerie I was quite moved. In the West, we often think of Arab cultures as sexually repressed societies, when – in fact – it turns out that they are clearly leaps and bounds ahead of us in advancements in lingerie technology. Those of us in Western cultures have a thing or two to learn from the Syrians about gaudy electronic lingerie. Henceforth, it became my mission to fast-forward lingerie technology in the West. I figured the first step in this critical mission was to replicate some of the advancements made in Syria. The article of lingerie that resonated most with my inner sensibilities was the clap-off bra. I immediately resolved to make my own clap-off bra as a springboard into Western lingerie innovation.

On a quiet morning, two years ago, I first set out to make a clap off bra in order to introduce it to a much more conservative Western audience. After a long arduous process, I am finally proud to present to you a reliably working prototype.

Step-by-step instructions to make your own *Clap-Off Bra* are available on *Instructables*: <http://www.instructables.com/id/Clap-Off-Bra/>

KYLE MCDONALD
Virtual Research Fellow

Kyle McDonald is a media artist who works with code, with a background in philosophy and computer science. He creates intricate systems with playful realizations, sharing the source and challenging others to create and contribute.

Kyle is a regular collaborator on arts-engineering initiatives such as openFrameworks, having developed a number of extensions which provide connectivity to powerful image processing and computer vision libraries.

For the past few years, Kyle has applied these techniques to problems in 3D sensing, for interaction and visualization, starting with structured light techniques, and later the Kinect. Kyle's work ranges from hyper-formal glitch experiments to tactical and interrogative installations and performance.

He was recently Guest Researcher in residence at the Yamaguchi Center for Arts and Media, Japan, and is currently adjunct professor at ITP.

<http://kylemcdonald.net/>

Happy Things

by Kyle McDonald February 2011

<http://fffff.at/happy-things/>

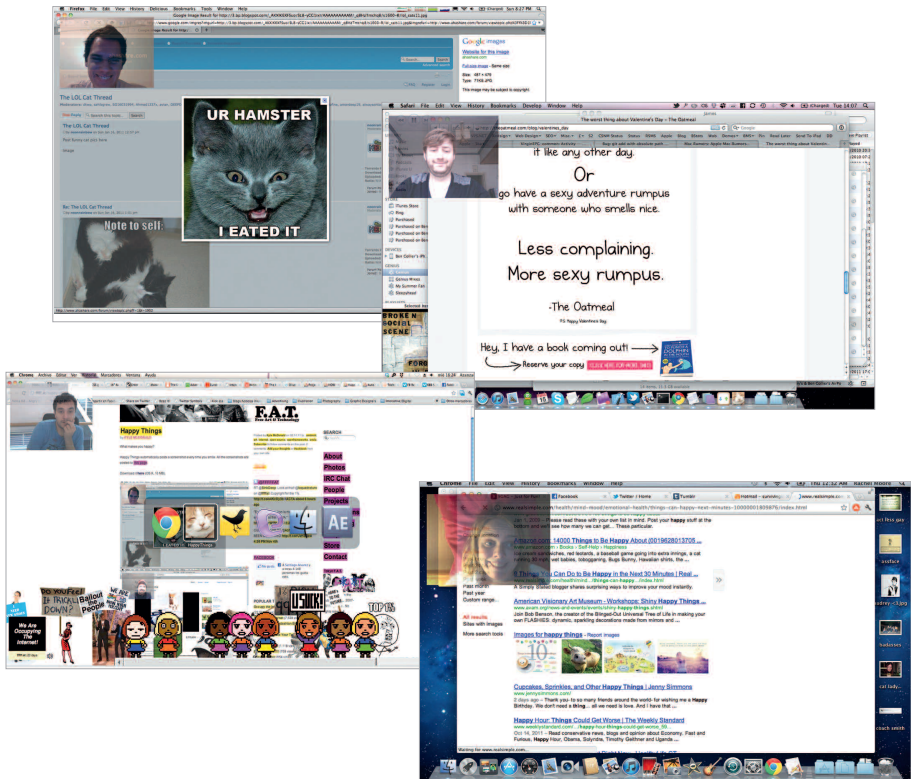

What makes you happy? *Happy Things* is a Mac OS X software that automatically posts a screenshot every time you smile.

The software is available for free download, and all the screenshots are posted to <http://kylemcdonald.net/happythings/>.

Happy Things is a speed project mashup between Theo Watson's *Auto-Smiley* and an unreleased project by Kyle McDonald.



Ai Weiwei FUCK OFF Bookmarklet

by Aram Bartholl May 2011

<http://fffff.at/ai-weiwei-fuck-off-bookmarklet/>



On April 3, 2011, artist Ai Weiwei was arrested at Beijing Capital International Airport just before catching a flight to Hong Kong and his studio facilities were searched. Along with Ai, police also detained eight staff members and Ai's wife, Lu Qing. While state media originally reported that Ai was arrested at the airport because his departure procedures were incomplete, the Chinese Ministry of Foreign Affairs said on 7 April that Ai was arrested under investigation for alleged economic crimes.

All around the world, activists started protesting against the Chinese government. *The Ai Weiwei FUCK OFF Bookmarklet* is a playful online contribution to the protests. Inspired to Ai Wei Wei's famous photo series *Study In Perspective*, where the artist's middle finger is positioned in front of some of the world's most notable man-made landmarks around the world, and based on the *Kanye Vision Bookmarklet* (2009) by Evan Roth and Tobias Leingruber, the program allows you to superimpose Ai's middle finger to any web page while surfing the web.

Free Ai Weiwei Glasses

by **Aram Bartholl** June 2011

<http://ffff.at/fffffree-ai-weiwei-glasses/>

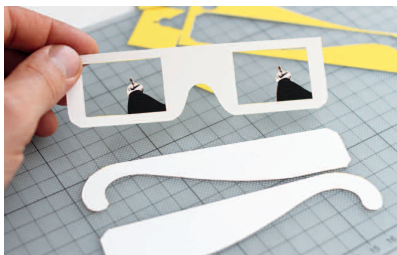
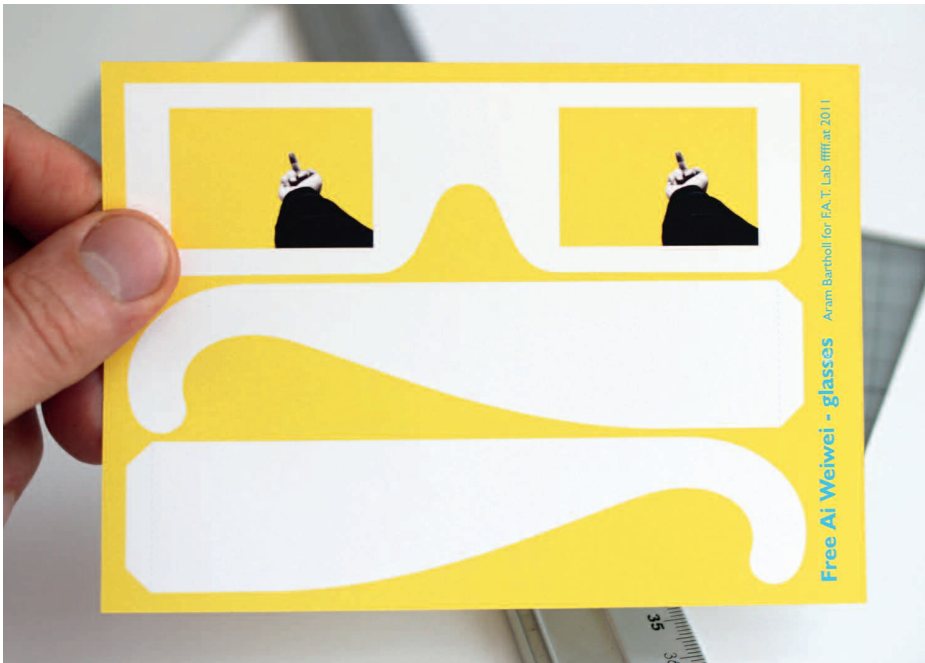

Free Ai Weiwei Glasses is a postcard and a DIY kit for making cardboard glasses bearing the Ai Wei Wei middle finger.

The work is based on Aram Bartholl's older project *First Person Shooter* (2006), in which the glasses are bearing the arm with the weapon which is typical of first person shooter (FPS) games, thus reproducing the way gamers look at the world while playing the game.

Infoviz Graffiti

by Golan Levin June 2011

<http://ffff.at/infoviz-graffiti-stencil/>

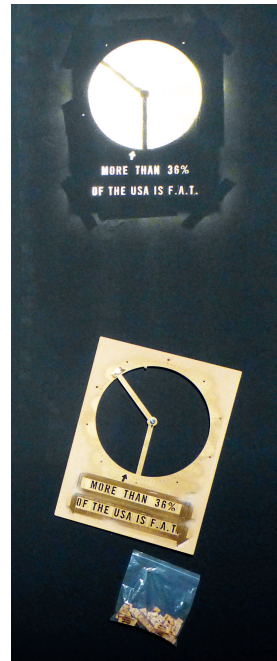
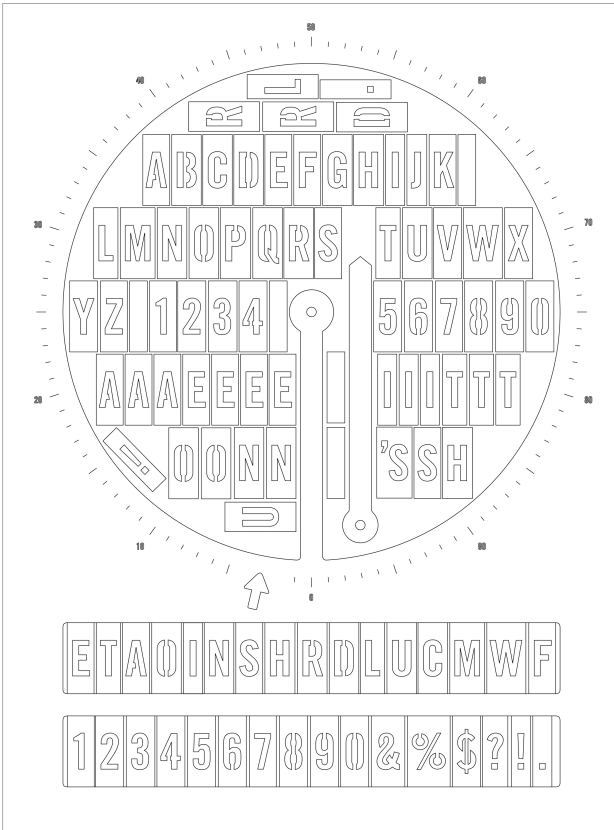

Infoviz Graffiti is an adjustable lasercut stencil pattern for pie-chart graffiti. The project addresses a lack of tools for the high-speed reproduction of info graphic messages in and around urban surfaces, and allows for quick tagging of pertinent data.

It is ideal for “locative info graphics” or “situated visualization” – when the content of a visualization-graffiti is highly coupled to the specific location at which it has been deployed.

The pattern includes a complete set of re-arrangeable letters and numbers. Changing the stencil’s message and pie-chart percentage is straightforward.

The stencil has a few noteworthy design features:

- The letters are designed to be held in place with adhesive tape.

Infoviz Graffiti

- The pie chart pointer is held in place by an adjustable-tension bolt and wing-nut.
- A small cutout arrow indicates which portion of the pie chart is described by your text.
- The perimeter of the pie chart is etched with 100 tick-marks, making it easy to adjust.
- The letters (a new stencilized version of Trade Gothic) preserve correct character widths and are provided in proportion to letter frequency.

If you'd like to make one for yourself, you'll need:

- 1/8" (3mm) thick sheet material, suitable for lasercutting.
I used MDF, but acrylic is fine.
- A one-inch 1/4"-20 bolt, wing-nut and suitable pair of washers.
- Scotch tape or masking tape (to hold the letter in the stencil).
- 1 quart-capacity Ziploc bag (for storing the letters).
- Spray paint.
- A laser cutter.

This four-hour Speed Project was developed by Golan Levin with support from the STUDIO for Creative Inquiry.

Thanks to Asa Foster III for production assistance.



People Staring at Computers

by **Kyle McDonald** July 2011

<http://ffff.at/people-staring-at-computers/>



People Staring at Computers is a photographic intervention in public spaces. Kyle McDonald wrote a simple application that took one picture every minute, and installed it in a couple of Apple stores in Lower Manhattan over three days. If the application found a face, it uploaded the photo to the artist's server.

Having collected more than a thousand photos, Kyle decided to exhibit them in the same places they were originally captured. So he wrote another app that could be remotely triggered after being installed on all the computers in one location. When the app starts up, it takes a picture and slowly fades in that photo.

A moment later, it starts cycling through older photos. Most people instinctively quit the app less than 10 seconds after recognizing their own face, so the exhibition was relegated to the unused machines. Apple's reaction came two days after the publication of the project on the F.A.T. website, on July 7, 2011. According to the *New York Times* [1], "he was awoken by Secret Service agents at his home in Brooklyn. They had a warrant to search for evidence that he violated the federal Computer Fraud and Abuse Act, and they left with his laptop. Then lawyers for Apple contacted Web sites that hosted video made by Mr. McDonald, including Vimeo and Tumblr, and told them the material might violate the law, that a criminal investigation was going

People Staring at Computers

on, and that they'd better take down *People Staring at Computers*. They did.”

F.A.T. Lab website as well received a letter from Apple demanding that the project be removed. Instead of doing it, on July 15, 2011 Evan Roth kept the pictures from the stores on place, but he photoshopped a Steve Jobs mask on the faces.

In 2012, the project got an Honorary Mention at the Prix Ars Electronica. Because the photos themselves may be subject to possible C&D requests from Apple, in the exhibition the work was presented in collaboration with artist David Pierce, who has interpreted the images in watercolor.

Despite Apple, many screenshots and a video documenting the project can still be found online.

Notes

- [1] Jim Dwyer, “Creating Art via Webcam, Secretly”, in *The New York Times*, July 19, 2011, online at www.nytimes.com/2011/07/20/nyregion/at-2-apple-stores-creating-art-via-webcam-secretly.html.

Media Artist Contingency Plan

by **Randy Sarafan** July 2011

<http://ffff.at/media-artist-contingency-plan/>



Does the US Secret Police not approve of your art? Are you a media artist who has gotten on the bad side of a private multinational corporation? Perhaps your government does not approve of the open source co-working tool that you host? Or maybe, you are simply just a troublemaker? Any which way, when Big Brother comes a-knockin' on your door

wanting to steal your computer, you need a contingency plan.

This informative little sticker will help guide you towards the quickest methodology of seriously damaging your laptop hard drive during that moment of urgency.

1. First of all, you will need to download one of these contingency plan sticker files. I recommend printing a full sheet and sharing them with friends and family: <www.ffff.at/contingency/singlesticker.jpg> or <www.ffff.at/contingency/stickersheet.jpg>.
2. Print out the file onto transparent adhesive full sheet labels.
3. Cut your sticker to size.
4. Research the build of your laptop and locate the position of your hard drive. You can use iFixit teardowns <<http://www.ifixit.com/>> to locate the position of your hard drive in most popular laptop makes and models. The hard drive should look like a rectangular box with a centered circle somewhere upon it.
5. Adhere the sticker to your laptop such that the circular drill guide is positioned above your hard drive, but slightly off from the hard drive's center. If you center it above where the hard drive should be, you might accidentally drill through the drive's motor instead of the platters.
6. If need be, and you are in a hurry, you can drill through the marked spot with a 1/4" drill bit. If you have a minute on your hands, you may want to consider drilling an 1/8" pilot hole and following up with a larger 3/8" hole. If you have a couple of minutes on your hand, you may want to drill multiple holes.
7. Possible, alternate methods include sawing through the center of the sticker with a Sawzall or angle grinder.



QR_STENCILER and QR_HOBO_CODES

by Golan Levin July 2011

<http://ffff.at/qr-stenciler-and-qr-hobo-codes/>



The F.A.T. Lab is pleased to present *QR_STENCILER*, a free, fully-automated utility which converts QR codes into vector-based stencil patterns suitable for laser-cutting. Additionally, we present *QR_HOBO_CODES*, a series of one hundred QR stencil designs which, covertly marked in urban spaces, may be used to warn people about danger or clue them into good situations. The *QR_STENCILER* and the *QR_HOBO_CODES* join the Adjustable Pie Chart Stencil in our suite of homebrew “infoviz graffiti” tools for locative and situated information display. The *QR_STENCILER* loads QR code image files, and exports vector-based PDF stencils.

About the Project

QR codes are a form of two-dimensional barcode which are widely used to convey URLs and other short texts through camera-based smartphones. A variety of free tools exist to generate QR codes (such as the Google Charts API) and to read them (such as TapMedia’s free QR Reader for iPhone app). Our *QR_STENCILER* is a Java-based software utility which loads a user-specified QR code image — from which it then generates a lasercutter-ready, topologically correct stencil .PDF. As Fred

QR_STENCILER and QR_HOBO_CODES

Trotter [1] has pointed out, QR codes contain stencil islands in unpredictable configurations. QR_STENCILER automatically detects and bridges these islands, using thin lines that are minimally disruptive to the highly robust QR algorithm. It does so through the use of two basic image processing techniques: connected component labeling (sometimes called blob detection) and 8-connected chain coding (sometimes called contour tracing). QR_STENCILER was created with Processing, a free, cross-platform programming toolkit for the arts.

Accompanying the QR_STENCILER are the QR_HOBO_CODES, a set of 100 lasercutter-ready QR stencil designs created with the QR_STENCILER software. These stencils can be understood as a covert markup scheme for urban spaces — providing directions, information, and warnings to digital nomads and other indigenerati. [2] We present these as modern equivalents of the chalk-based "hobo signs" [3] developed by 19th century vagabonds and migratory workers to cope with the difficulty of nomadic life. Indeed, our set of QR stencils port a number of classic hobo annotations to the QR format ("turn right here", "dangerous dog", "food for work") as well as some new ones, with a nod to warchalking, [4] that are specific to contemporary conditions ("insecure wifi", "hidden cameras", "vegans beware").

Download & Instructions

QR_STENCILER has been tested in MacOSX 10.6.8, but (since Processing is a cross-platform toolkit) it should work in Windows or Linux as well.

1. Make yourself a QR code image which embeds a short piece of text. GoQR.me, Google and Kaywa all provide free online QR generators. To reduce the complexity of the stencil, we recommend generating your code with the shortest possible texts, and with lower levels of error correction (L-level or M-level). At the same time, we recommend generating QR code images with more pixel resolution, such as 500x500px; for QR_STENCILER, the ideal input image has a "grid size" of about 20 image-pixels per QR grid-cell.
2. Download QR_STENCILER.zip
<http://ffff.at/files/2011/07/QR_STENCILER.zip>, and unzip this to a folder.
3. Although the zip includes compiled executables for Mac, Windows and Linux, we recommend running the QR_STENCILER from the Processing development environment. Download and install the Processing development tool. The QR_STENCILER works with Processing v.1.5.1 or later.
4. Put your QR code image in the folder, 'QR_STENCILER/data/'
5. Launch Processing and open 'QR_STENCILER.pde'
6. Press 'Run' (Command-R) to start the stenciler.

QR_STENCILER and QR_HOBO_CODES

7. You will be prompted to Open your QR code image. (A default “hello world” QR code will be opened if none is provided).
8. After opening the QR code image, the program will generate a stencil .PDF in the ‘data’ folder. Note that there are some options (checkboxes, sliders) which you can use to alter the generated stencils in various ways, including (for example) generating “reverse” (white-on-black) stencils.
9. The .PDF can be opened in your favorite CAD program, for laser-cutting materials like cardboard, delrin, MDF or acrylic. (Of course, you could always print out the PDF on paper if you prefer to cut the stencil by hand. Cheap!)
10. For non-permanent outdoor marking materials, we recommend Erwin Strait-Line 64908 powdered chalk; black spray chalk; black finger paint; and Crayola Sidewalk Paint.
11. After marking your stencil, test it with a QR code reader, such as TapMedia’s free QR Reader for iPhone app.

License

The QR_STENCILER software is provided “as is”, without warranty of any kind. QR_STENCILER is licensed under a Creative Commons Attribution-NonCommercial-ShareAlike 3.0 Unported License.

You are free to distribute, remix, and modify QR_STENCILER, so long as you share alike and provide attribution to FFFFFF.AT.

The repackaging of QR_STENCILER as or into commercial software, is expressly prohibited.

Please note that QR_STENCILER also enjoys protections under the GRL Repercussions 3.0 license. More details about QR_STENCILER’s license and warranty can be found in the preamble to its main code file, QR_STENCILER.pde; for other uses, please contact us.

The 100 QR_HOBO_CODES and their respective stencils are hereby dedicated to the public domain.

Acknowledgments

QR_STENCILER was created by Golan Levin and Asa Foster III with support from the STUDIO for Creative Inquiry at Carnegie Mellon University. Thanks to Ben Fry, Andreas Schlegel, Marcus Beausang, Neil Brown & Judy Robertson for the terrific code they have made available online. A tip of the hat to Fred Trotter, Jovino, Ric Johnson, le Suedois, Patrick Donnelly, David J. Burden, Matt Jones and others who have gone down similar or related paths. Additional thanks to Andrea Boykowycz for creative input. Some of the QR_HOBO_CODES are adapted from or inspired by designs presented elsewhere by Fran DeLorenzo and Cockeyed.com. “QR code” is trademarked by Denso Wave, Inc.

QR_STENCILER and QR_HOBO_CODES

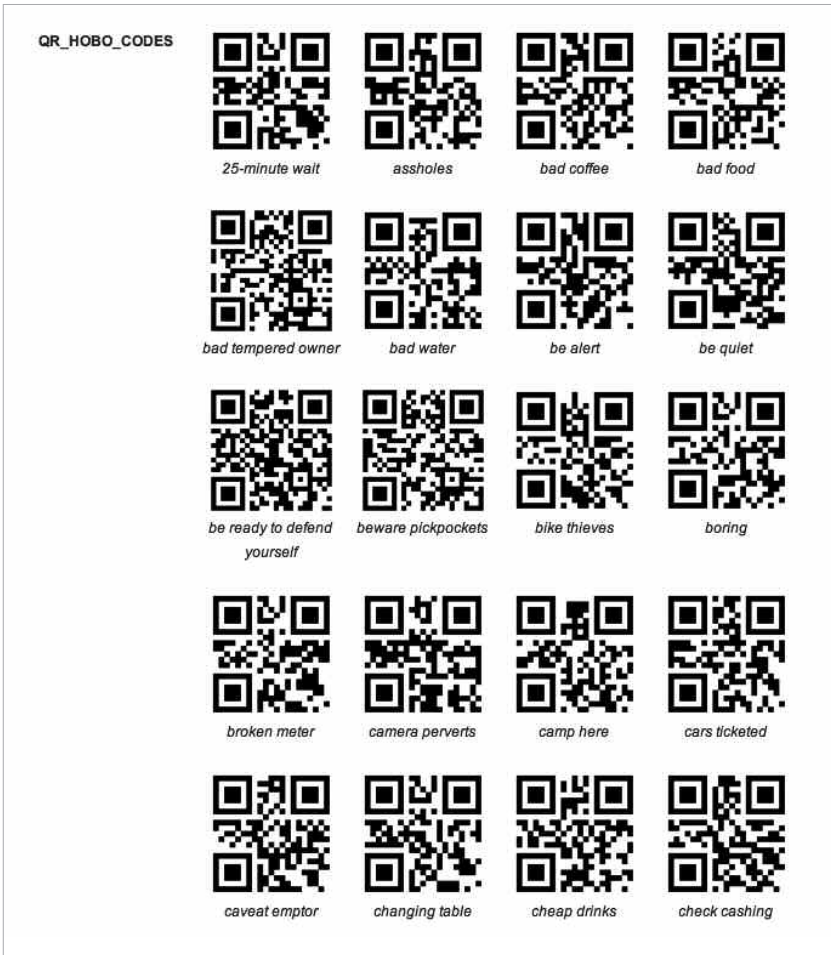

Notes

- [1] Fred Trotter, "QR code stencils, the problem", March 2, 2011, online at <http://www.fred-trotter.com/2011/03/02/qr-code-stencils-problem/>.
- [2] Digital nomads are individuals that leverage digital technologies to perform their work duties, and more generally conduct their lifestyle in a nomadic manner. Such workers typically work remotely - from home, coffee shops and public libraries to collaborate with teams across the globe. They frequently use new technologies like a smartphone, wifi, and web-based applications to enable their lifestyle, and earn an income wherever they live or travel.
- [3] "A hobo is a migratory worker or homeless vagabond, especially one who is penniless. The term originated in the Western - probably Northwestern - United States around 1890. Unlike "tramps", who work only when they are forced to, and "bums", who do not work at all, "hobos" are workers who wander. [...] To cope with the difficulty of hobo life, hobos developed a system of symbols, or a code. Hobos would write this code with chalk or coal to provide directions, information, and warnings to other hobos."
From *Wikipedia*, <http://en.wikipedia.org/wiki/Hobo>.
- [4] "Warchalking is the drawing of symbols in public places to advertise an open Wi-Fi network. Inspired by hobo symbols, the warchalking marks were conceived by a group of friends in June 2002 and publicised by Matt Jones who designed the set of icons and produced a downloadable document containing them."
From *Wikipedia*, <http://en.wikipedia.org/wiki/Warchalking>.

Digital Purchase Takedown Notice

by Greg Leuch August 2011

<http://fffff.at/digital-purchase-takedown-notice/>

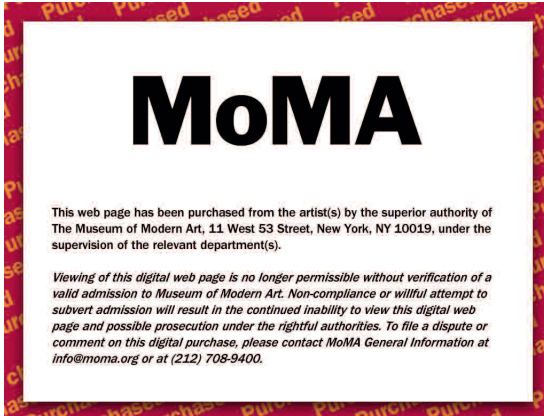

As net art is entering into widespread recognition, a trend of purchasing is occurring by interested collectors. Instead of the takedowns typically seen from Homeland Security / FBI domain seizures, collectors are issuing their own takedown notices as digital web pages are being entered into private galleries & museums, removing these pieces from the public visibility that gave these artists and their digital works their viewing audience. Don't be surprised when you see a digital purchase takedown notice on your favorite net.art piece.

Make your own: Download the Purchase Takedown Notice PSD (1.2MB):
 <<http://fffff.at/files/2011/08/digital-purchase-takedown-notice.psd>>



Show Me Videos Non-Stop

by **Jamie Wilkinson** September 2011

<http://ffff.at/showmenonstop/>

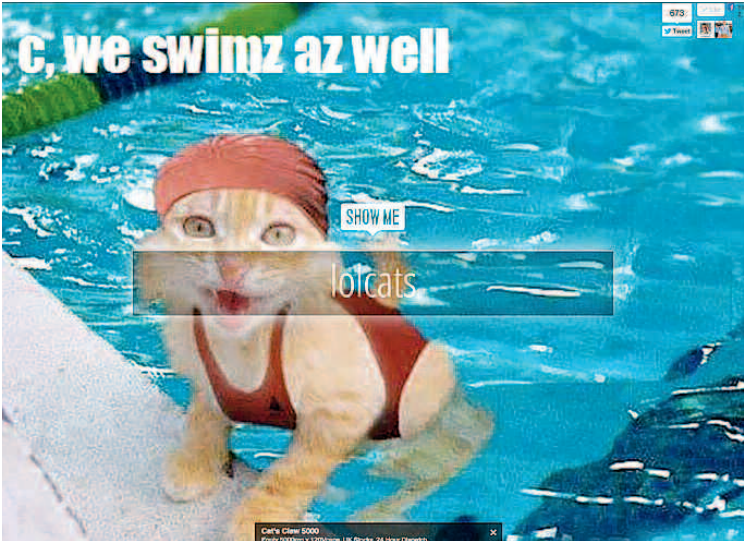

showmenonstop.com is a search engine that endlessly plays videos based on your search term. Type anything in the box for a continuous, full-browser stream of videos. Get as specific as you want, e.g. dogs welcoming soldiers home. The app is just HTML & javascript using a customized VHX embed player — one with no play/pause button. VHX <<http://vhx.tv/>> is a distribution platform that helps video creators to distribute, promote and generate income from their creations.

Made in collaboration with Chad Pugh and Casey Pugh at the 24 hour hackday.tv event.



Dead Drop Installed at Abandoned U.S. Spy Station

by Tobias Leingruber September 2011

<http://ffff.at/dead-drop-installed-at-abandoned-u-s-spy-station/>



A dead drop is a container placed in a hidden location to transmit secret messages, typically used by spies. *Dead Drops* <<http://deaddrops.com/>> is an anonymous, offline, peer to peer file-sharing network in public space, consisting of USB flash drives embedded into walls, and started by Aram Bartholl in 2010.

In September 2011, volunteer agents of the Dead Drop network installed a Dead Drop at the highest point of the Teufelsberg in Berlin, a former U.S. NSA “listening” aka spy station (Echelon).

The dead drop apparently contains confidential cold war material – Do NOT put it on the internet.

The Googler

by **Randy Sarafan** October 2011

<http://ffff.at/the-googler/>



The Googler is a device which plugs into your computer and triggers a bullet vibrator any time that Google pings your web browser (with the aid of *The Googler* Firefox Add-on). By doing so, *The Googler* translates Google's pervasive reach into highly stimulating vibrations for vaginal or anal web browsing. Mistrust and fear Google's omnipotent ways no longer as the web giant profoundly soothes, touches, and moves you. This is perhaps the biggest thing to happen to augmented reality since the invention of methamphetamine. *The Googler* was produced with both open source software and hardware. The *Googler* Firefox Add-on is based on Jamie Wilkinson's *Google Alarm*. Follows are directions to make your own Google-responsive vibrator. Build one and let Google touch you where it counts.

Materials:

- (x1) The Googler Firefox addon
- (x1) USB Audio Dongle (with headphone jack)
- (x1) Hammond 125-B white powder coated case
- (x1) Silver Bullet Vibrator
- (x1) Female USB-B jack
- (x1) Female USB-A jack (I got mine from a Mac G4 keyboard that has them built in for the mice)
- (x2) PCBs
- (x1) HT9170 DTMF decoder
- (x1) CD4021 shift register
- (x1) Arduino (with ATMEGA328 DIP chip)
- (x1) 16MHz crystal
- (x1) 3.579545MHz crystal

The Googler

(x4) 22pf capacitors (x3) 0.1uF capacitor
(x1) 100uF capacitor (x1) 10uF capacitor
(x2) 100K resistors (x1) 300K resistor
(x4) 10K resistors (x1) 1K resistor
(x1) 1N4001 diode (x1) IRF510A MOSFET
(x1) 1" shrink tubing
(x1) 12" square of 1/8" acrylic
(x1) 6" square of 3/8" acrylic
(x4) nuts and bolts
(x1) Printable transparent sticker sheet
(x1) misc. tape and glue
(x1) soldering setup
(x1) tools and junk

1. The first thing you need to do is to cut a square hole in the side of your case in which to put the USB jack.
2. After you have made a nice square hole in one side, it is time to make a tiny round hole in the other. Affix your guide to the case and drill a 1/4" hole (or appropriate for your jack... always measure).
3. Open up the vibrator controller and remove the 3/32" (2.5mm) jack.
4. Attach new longer wires to each terminal of the jack.
5. Wire together the USB-B jack and the female USB-A jack that was pulled from the Mac keyboard. To figure out which wire goes to which terminal, plug in a USB cable between the two and use a multimeter to test for continuity.
6. It is circuit building time. First, let us understand what is happening. A DTMF tone from the Firefox addon is sent via the audio port of the USB dongle into a HT9170 DTMF decoder. The decoder chip sets 4 consecutive pins to either high (5v) or low (0v) depending on the tone it detects. These 4 pins are connected to the inputs of a CD4021 shift register, which in turn converts them into a 4-bit number between 0 and 15. This number is sent to the ATMEGA328 chip, which is programmed using the Arduino development board. The ATMEGA328 finally takes the number it receives and vibrates the motor accordingly. The circuit is pretty straight forward, but there are a few things to note. First of all, on account of the power demands of the motor, the circuit needs a couple filter capacitors to function reliably. I put a 47uF capacitor where the power source enters the board. I put 0.1uF capacitor between positive and ground as close to the ATMEGA328 as possible. I also put a 10uF cap near the power source to shift register.

The Googler

Then,

11. laser cut the following file out of 3/8" acrylic:
<<http://ffff.at/googler/TGspacers.eps>> If you don't have a laser cutter, you can use a service like ponoko.com or you can print out the files and just cut them out the old-fashioned way. Fasten the circuit boards to the bracket using your nuts, bolts and spacers. Make certain that none of the connections between the two boards accidentally touch each other.
12. It turns out that when you insert a positively powered jack (the motor jack) and a negatively powered jack (the USB jack) into a metal case, it shorts the power and makes your computer's USB jack really unhappy. Therefore, it is essential that one of these jacks be insulated. I felt like I had more wiggle room with the USB jack, so I insulated it with heat shrink tubing. For the job I used 1" diameter heat shrink, but would probably have been better off with 3/4" diameter tubing.
13. When you are certain that it is working, trim away the audio jack from the circuit board and solder the two audio wires to the USB dongle.
14. Epoxy the USB jack into case. (Shhhhh.... I also touched up the outside of the case around the USB jack with white enamel model paint.) Insert the circuit board into the body of the case. Plug in the USB Dongle. Fasten the 3/32" jack. Put the lid on the case and fasten it shut with the screws.
14. Download the following file: <<http://ffff.at/googler/googler.jpg>>
15. Print it on transparent sticker paper. Cut it to size and stick it to your case.
16. Download and install The Googler Firefox addon
<<http://ffff.at/googler/the-googler.xpi>> if you haven't done so already. Plug it in and enjoy!

Note: If you are hearing annoying beeps instead of feeling wonderful vibrations, then you need to configure your computer to output through the USB dongle instead of the built in speakers.

A full tutorial with images and download links is available here:
<http://ffff.at/diyds/googler/>.

CHRISTOPHER “MOOT” POOLE **Virtual Research Fellow**

“Christopher Poole (born c. 1988) is an American internet entrepreneur from New York City, noted for founding the websites 4chan and Canvas. He originally started 4chan anonymously, under the pseudonym moot (always written with lower case). In 2008, Leopoldo Godoy of Brazilian TV Globo called Poole’s 4chan “the ground zero of Western web culture.”

In April 2009, Poole was voted the world’s most influential person of 2008 by an open Internet poll conducted by Time magazine. The results were questioned even before the poll completed, as automated voting programs and manual ballot stuffing were used to influence the vote. 4chan’s interference with the vote seemed increasingly likely, when it was found that reading the first letter of the first 21 candidates in the poll spelled out a phrase containing two 4chan memes: ‘mARBLECAKE. ALSO, THE GAME’.”

You can go on reading moot’s bio directly on Wikipedia <http://en.wikipedia.org/wiki/Christopher_Poole>, or rather choose this one: <<https://encyclopediadramatica.se/Moot>>.

Occupy the Internet

by **F.A.T. Lab** October 2011

<http://fffff.at/tag/occupy/> and <http://occupyinter.net/>

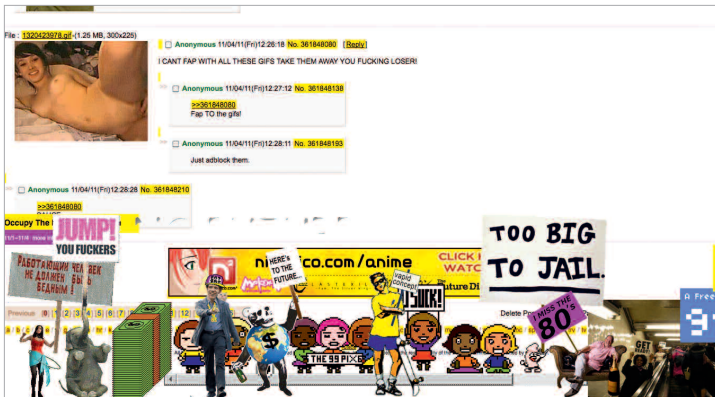

Concept development by Theo Watson, Geraldine Juárez, Jamie Wilkinson, Greg Leuch, Evan Roth, Aram Bartholl, and Tobias Leingruber. Code development by Jamie Wilkinson, Greg Leuch, Theo Watson, and Tobias Leingruber.

Are you a “webmaster”, admin, blog owner or someone with access to index.html files? Are you interested in taking part in the recent global wave of revolution from the comfort of your home computer? Occupy the Internet! Add the animated GIF army to websites you control (or can get control of) by pasting the following code into any HTML file:

```
<script src="http://occupyinter.net/embed.js"></script>
```

OCCU(PI) Bot

by Randy Sarafan November 2011

<http://ffff.at/occupi-bot/>

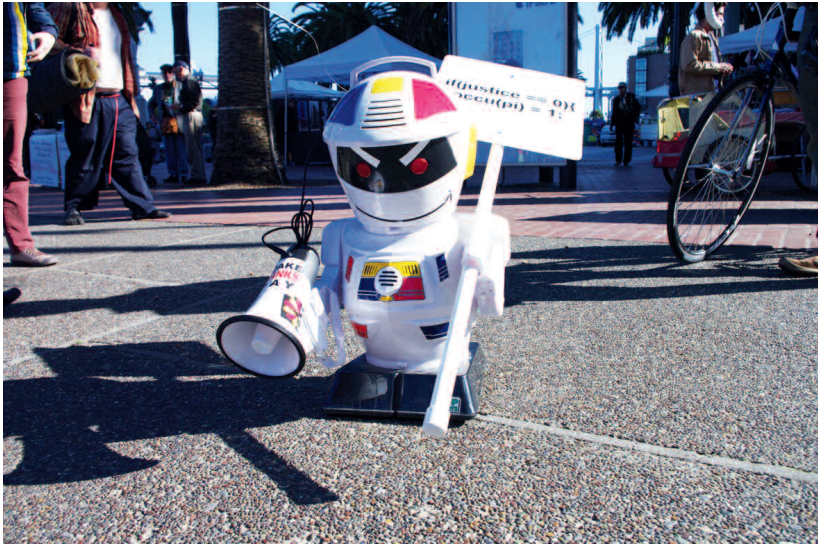

Learning from the lessons of the 1%, I set forth to outsource our occupy-related labor to a robotic workforce. Robots obviously have many advantages over their human counterparts. For instance, robots never get tired, they don't get cold, they don't sleep, nor eat, don't require tents, and when armed insurrection becomes necessary, robots are much more morally ambivalent. Additionally, we had a discussion with an unnamed member of the San Francisco police force and they confided in us that the police currently do not have any plan for dealing with robotic occupiers. For all of those reasons and more, I present to you *Occu(pi)* Bot; the first in a promising line of tireless, unstoppable, robotic class warriors.

Step 1: Go get stuff

You will need:

- A robot (My robot's name is Emilio. He is Italian)
- A megaphone (or battery-powered amplifier)
- An 1/8" male-to-male stereo cable
- Optional Arduino and Wave Shield (or a tape recorder and computer)
- M-type plug (also optional - see step 5)
- 9V battery clip (also optional - see step 5)
- 9V battery (also optional - see step 5)
- Soap dish (also optional - see step 5)

OCCU(PI) Bot

- 4' x 3/4 PVC pipe
- Something for a sign board (I used acrylic, but cardboard would do)
- Something to write a slogan (I used acrylic paint, but a Sharpie would work)
- Some tape, nuts and bolts, and zip ties
- And whatnot

Step 2: Mod a megaphone

If your megaphone doesn't already have an audio input jack, add one by following these instructions: <www.instructables.com/id/Megaphone-Audio-Input/>

If a megaphone is too large and/or inappropriate for your bot, or you just want to use something different, you can try using a Radioshack Mini Audio Amplifier. This battery-powered amplifier is cool because not only does it have a built in speaker, but it also has an output jack to drive any small-sized speaker you wish. Or, if your robot just has its own darned sound system, let it speak for itself.

Step 3: Make a sign

Making a sign is one of the most important parts. If the robot can't make it's own sign, you are going to need to make a sign for it.

First ask the robot what it would like to say. If the robot does not answer you, just take an educated guess. Once you are sure what is supposed to be on the sign, make one on something "roboty" using "robot-ish" kind of tools. For instance, I made my robot Emilio a sign on white acrylic using a laser cutter. If that does not make one nostalgic for our promised robotic future, I don't know what does.

Step 4: Attach it to a post

This is probably the third or forth most important part of this Instructable. Simply attach your sign to a post. I found that PVC looked very robot-ish. If your robot isn't into gripping posts, it also wear the sign like a sandwich board. It is really up to the robot's discretion.

Step 5: Make a pi reader (optional)

If you would like for your occu(pi) bot to speak the digits of pi, pay attention now. If you think reading the digits of pi is just plain geeky and annoying, skip to the next step. Plug your wave shield kit into your Arduino. Put your arduino inside of a box and then connect the Arduino to your computer.

Upload the "PI party!" example from the ladyada.com examples page: <www.ladyada.net/make/waveshield/examples.html>

OCCU(PI) Bot

Now, when you power up your Arduino, it will read off the digits of pi. This is kind of very annoying... but is slightly better than robotic silence.

Step 6: Plug'er up

Plug your robot's audio-out port to the megaphone. Program your robot to say whatever it wants. This is the robot's chance to be heard.

My robot Emilio has a feature that allows me to talk through his microphone. In some ways, this makes me his inner conscience.

If your robot does not have an audio out port, fret not. You can either make a pi reader as outlined in the last step, or if that is too complicated, you can always get a cheap MP3, CD, or cassette player and affix that to your robot and load it with pre-made audio clips.

If you are feeling somewhat enterprising, you can crudely hack a cheap walkie talkie and replace its microphone with an audio out jack (you might need to add a 10K - 47K resistor in series with the audio out signal).

In this way, you too can be the inner conscience of a robot.

Step 7: Power up!

Dress your robot up in its finest attire. Make sure it has its sign and knows what it wants to say. Once everything is all set, power up your robot and prepare for occupation.

Step 8: Occu(pi)

Identify a nice public spot and program your robot not to leave until there is justice for all.

Complete tutorial is available on *Instructables*:

<http://instructables.com/r/occupy/>.

Scratch Markup Language

by **Jamie Wilkinson, Kyle McDonald and LM4K** January 2012

<http://ffff.at/scratch-markup-language-sml/>



SML (*Scratch Markup Language*) is a new file format for recording and replaying turntablism. Open-source tools have been developed for accurately capturing the record and crossfader movements of a scratch DJ, allowing us to analyze, transcribe, and recreate scratch performances. With SML, F.A.T. Lab wants to do for turntablism what *Graffiti Markup Language* has done for tagging — especially teaching giant robot arms how to scratch.

The project was launched at the Art Hack Day [1] organized in January 2012 at 319 Scholes, Brooklyn, New York. Timecode vinyl was used to capture record movements and a hacked VCA fader + Arduino to record the crossfader. Scratch data was saved to disk as .sml and broadcast as OSC, which allowed other Art Hack Day participants to build visualizations based on what the DJ was scratching during the exhibition. The apps ranged from spinning-vinyl animations and TTM transcriptions to insane exploding 3D pizzas and a side-scrolling videogame shooter controlled by scratches.

The goal is to make capturing, replaying, and sharing a scratch performance accurate and easy. SML files can be freely uploaded and downloaded from the ScratchML.com database.

Notes

[1] Art Hack Day is an internet-based nonprofit dedicated to hackers whose medium is art and artists whose medium is tech. Since its beginning, it organized events in New York City, Boston, San Francisco, Stockholm and Berlin. More information: <http://arthackday.net/>.

Scratch Markup Language Fader Hack

by **LM4K** February 2012

<http://fffff.at/scratch-markup-language-fader-hack/>



How did we track the crossfader during the Art Hack Day?!? ZOMG!! So many questions!

The answer is very simple! We used a VCA Mixer. Specifically the Vestax PMC-07 Pro. Because you know... we're pro like that.

I hear you asking now, "But, sir! WTF is a VCA Mixer?!?"

Well, I'm glad you asked. Allow me to explain: VCA or Voltage Controlled Amplifier means that instead of sending the audio signal to the crossfader the mixer sends a voltage which in turn controls the volume level for each channel. This makes determining the position of the fader very easy; simply measure the voltage for each channel.

In the case of the PMC-07 Pro the voltage that is sent to the crossfader is 10V DC. We used an Arduino Uno [1] to monitor the voltage.

It maxes out at 5V. Not wanting to explode the Arduino with 10V we used a simple voltage divider [2] on each channel utilizing two (four total) 1 megaohm resistors. We would have been a lot better off using 100 kilohm resistors. Using an opamp would have been even much better but... we didn't have any of those.

Because we're so damn pro and didn't have any of the parts to make a proper Y cable we just soldered everything to the crossfader.

Go team awesome!

Yes, I hear you. You're wondering, "That's all well and good, but how am I supposed to hook it all up?!?"

Simple! Follow these amazeball instructions. The PMC-07 Pro uses a 4 pin connector on the crossfader. The outside pins are power and ground the

Scratch Markup Language Fader Hack

middle pins are for the channels. Use a volt meter to determine which pin is power and which pin is ground. Plug ground into one of the ground pins on the Arduino and the two center pins from the fader through a voltage divider and into two analog pins on the Arduino. We used A0 and A1. You do not need to hook anything up to the 10V power pin on the mixer. Got it?

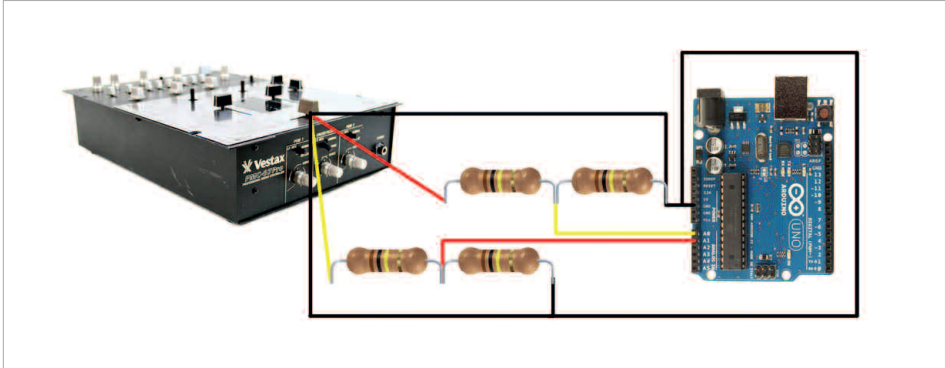

Here is a list of items you should have to do this:

- Vestax PMC-07 Pro mixer (Any VCA mixer will do, just drop the voltage to 5V or less.)
- Four 100 kilohm resistors
- An Arduino
- A proper Y cable for the PMC-07 Pro
- The Arduino sketch we made available here: github.com/scratchml.

Build your Y cable. Make a couple voltage dividers. Hook it up like the picture above and BLAMO!

Step-by-step instructions are available on *Instructables*:
www.instructables.com/id/Scratch-Markup-Language-VCA-Fader-Hack/.

Notes

[1] Cf. www.adafruit.com/products/50.

[2] "a voltage divider (also known as a potential divider) is a linear circuit that produces an output voltage (V_{out}) that is a fraction of its input voltage (V_{in}). Voltage division refers to the partitioning of a voltage among the components of the divider."
 From *Wikipedia*, http://en.wikipedia.org/wiki/Voltage_divider.

Noisy Typer

by Theo Watson July 2012

<http://fffff.at/noisy-typer-a-typewriter-for-your-laptop/>



Noisy Typer is a free piece of software for OS X which plays typewriter sounds as you type. It runs in the background and works with all applications (email, web, texts editors etc.). Key sounds include: letter keys, spacebar, backspace, carriage return and scroll up and down.

The software is open source and made with openFrameworks version 0071. Download link: <http://theo.tw/noisy/NoisyTyper-v001.zip>.

Note: to quit the app type "qaz123".

Social ID Bureau

by Tobias Leingruber February 2012

<http://socialidbureau.com/>

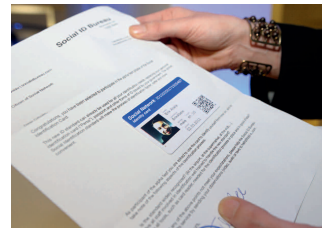

The *Social ID Bureau* (2012 – ongoing) is a performance and viral media project exposing the current status and possible future of (online) identity. By creating and distributing Social ID cards it shows how digital identity is not necessarily in the hands of governments anymore. It also blurs the lines between “real life” and “digital life”. The project received the ARTE Creative Award 2013.

The project – originally called “Facebook ID Bureau” – launched one week before the accompanying performance at Supermarkt Berlin, organized on March 2, 2012. It certainly struck some nerves and received international media coverage within a couple of days. At the performance Leingruber handed-out 150+ “Facebook ID Cards”. Sadly the project also received legal complaints from Facebook Inc., which is why its original URL (fbbureau.com), the letters “FB” and the Facebook Inc. logo are no longer used in the piece.

Can I See your Facebook ID?

With more than 800 million users Facebook is the dominant identity system on the web. When signing-up for new services around the open

Social ID Bureau

web it's quite common to use Facebook Connect instead of creating a new user account. People stop ranting on blog comments because they only allow comments connected to your "real name" aka "Facebook Identity" (till the end of time). For the good or bad we are losing anonymity and Facebook Inc. is establishing order in this "world wild web".

Governments like Germany have released new passports that offer online identity checks as well, but they will likely never succeed with their technologies given the already existing structure of Facebook, powered by convenience. The other way around though – a future where a Facebook Identity becomes more important than any governments' – doesn't seem unrealistic. This possible future is already half-way there. What is exciting about this, what can be our role as artists and why should one even bother? Let's find out!

Next time someone needs to "see your ID" – how about showing a Facebook ID card instead of the documents your government gave you? On the web this is common practice for millions of people already. Therefore – forget privacy. The user's next battle is about nothing less but who controls your identity, and we still might have something to say about it.

Background

When crossing the border from Canada to the U.S. last summer the border officer jokingly asked me: "So - What is your Facebook Name?"

The predecessor of this project is *FB Resistance* <<http://fbresistance.com/>>, a series of workshops to encourage people to question the rules and restrictions of Facebook by showing them the basics of web technologies, open data and creating little "hacks" that open new perspectives.

The Free Universal Construction Kit

by F.A.T. Lab March 2012

<http://ffff.at/free-universal-construction-kit/>

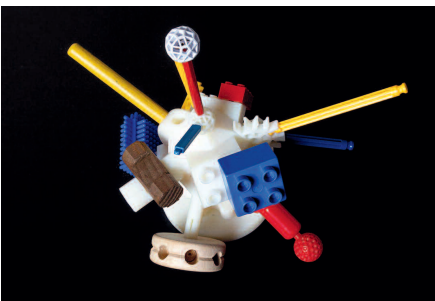
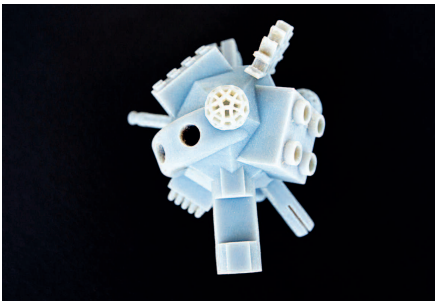

Ever wanted to connect your Legos and Tinkertoys together? Now you can – and much more. Announcing the *Free Universal Construction Kit*: a set of adapters for complete interoperability between 10 popular construction toys.

The Free Universal Construction Kit

Overview

F.A.T. Lab and Sy-Lab are pleased to present the *Free Universal Construction Kit*: a matrix of nearly 80 adapter bricks that enable complete interoperability between ten popular children’s construction toys. By allowing any piece to join to any other, the Kit encourages – totally new forms of intercourse between otherwise closed systems – enabling radically hybrid constructive play, the creation of previously impossible designs, and ultimately, more creative opportunities for kids. As with other grassroots interoperability remedies, the *Free Universal Construction Kit* implements proprietary protocols in order to provide a public service unmet – or unmeetable – by corporate interests.

The *Free Universal Construction Kit* offers adapters between Lego, Duplo, Fischertechnik, Gears! Gears! Gears!, K’Nex, Krinkles (Bristle Blocks), Lincoln Logs, Tinkertoys, Zome, and Zoob. Our adapters can be downloaded from Thingiverse.com and other sharing sites as a set of 3D models in .STL format, suitable for reproduction by personal manufacturing devices like the Makerbot (an inexpensive, open-source 3D printer).

Motivation

Our kids are already doing it! And when we were growing up, ourselves, we did it too – or we tried to, anyway. Connecting our toys together. Because: what if we want to make a construction which is half-Tinkertoys, half-K’Nex? Why shouldn’t we be able to? We dreamed about this possibility years ago, when we were small, and we knew then, as we know now, that we’d need some adapters to help. The advent of low-cost 3D printing has made such adapters possible, and with it, a vast new set of combinatorial possibilities for children’s creative construction toys.

Opening doors to new creative worlds is one major reason we created the *Free Universal Construction Kit*. Another is that we believe expertise shouldn’t be disposable – and that childrens’ hard-won creative fluency with their toys shouldn’t become obsolete each Christmas. By allowing different toy systems to work together, the *Free Universal Construction Kit* makes possible new forms of “forward compatibility”, extending the value of these systems across the life of a child. Thus, with the Kit’s adapters, playsets like Krinkles (often enjoyed by toddlers) can still retain their use-value for older children using Lego, and for even older tweens using Zome.

The Free Universal Construction Kit

The Kit offers a “best of all worlds” approach to play and learning that combines the advantages of each toy system. We selected construction sets for inclusion based on their significant level of market penetration, as well as for the diversity of features they brought to the Kit’s collection. Some of the supported construction systems, for example, offer great mechanical strength, or the ability to build at large scales; others offer the means to design kinetic movements; and still others permit the creation of a wide range of crystallographic geometries and symmetries. Using these classic toys as a foundation, the *Free Universal Construction Kit* offers a “meta-mashup system” ideally provisioned for the creation of transgressive architecture and chimeric readymades.

Finally, in producing the *Free Universal Construction Kit*, we hope to demonstrate a model of reverse engineering as a civic activity: a creative process in which anyone can develop the necessary pieces to bridge the limitations presented by mass-produced commercial artifacts. We hope that the Kit will not only prompt people to create new designs, but more importantly, to reflect on our relationship with material mass-culture – and the rapidly-evolving ways in which we can better adapt it to our imaginations.

Download

The *Free Universal Construction Kit* 3D models are freely available in .STL format from three locations:

- Individual adapters from the *Free Universal Construction Kit* may be downloaded from Thingiverse.com – the world’s foremost website dedicated to the free sharing and remixing of user-created digital design files.
- The complete *Free Universal Construction Kit* can also be downloaded in its entirety, as a 29MB .zip archive from the F.A.T. Lab web site, here: <<http://media.fffff.at/free-universal-construction-kit/free-universal-construction-kit.zip>> Note: all units are in inches.
- We expect the Kit to be available shortly from The Pirate Bay, as a torrent in TPB’s new “physibles” (physical downloadables) channel.

In addition to the Kit itself, we also offer for download this attractive B1 poster (4.5MB PDF, in two versions: gray background / white background).

The Free Universal Construction Kit



FREE UNIVERSAL CONSTRUCTION KIT

The F.A.T. Lab and Sy-Lab present the Free Universal Construction Kit, a collection of unique bricks that enable complete interoperability between two popular children's construction toys. By allowing any piece to join to any other, the kit encourages new forms of interplay between different brand systems — enabling the creation of previously impossible designs, and even creative opportunities for both. The kit adapters can be downloaded from Thingiverse.com and other sharing sites as a set of 3D models in STL format, suitable for reproduction by personal fabrication systems. >>> For more information, please see: <http://FAT.Lab/free-universal-construction-kit>

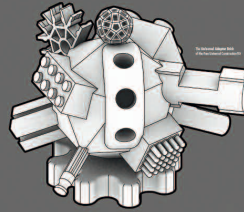

| | | | | | | | | |
|--|--|---|--|--|---|---|---|---------------------------------------|
| Duplo® © 2009 The LEGO Group | Fischertechnik® © 1999 Fischertechnik AG | K'Nex® © 2004 K'Nex Systems, Inc. | Krinkles® © 2004 K'Nex Systems, Inc. | Legø © 2009 The LEGO Group | Lincoln Logs® © 1999 Lincoln Logs, Inc. | Tinkertoy® © 1999 Tinkertoy, Inc. | ZomeTool® © 2000 Zometech, Inc. | Zoob® © 2000 Zometech, Inc. |
| (Duplo to Duplo) | (Fischertechnik to Fischertechnik) | (K'Nex to K'Nex) | (Krinkles to Krinkles) | (Legø to Duplo, already supported by manufacturer) | (Legø to Legø) | (Tinkertoy to Tinkertoy) | (ZomeTool to ZomeTool) | (Zoob to Zoob) |
| | | | | | | | | |
| | | | | | | | | |
| | | | | | | | | |
| | | | | | | | | |
| | | | | | | | | |
| | | | | | | | | |
| | | | | | | | | |
| | | | | | | | | |
| | | | | | | | | |
| | | | | | | | | |
| | | | | | | | | |
| | | | | | | | | |
| | | | | | | | | |
| | | | | | | | | |
| | | | | | | | | |
| | | | | | | | | |
| | | | | | | | | |
| | | | | | | | | |
| | | | | | | | | |
| | | | | | | | | |
| | | | | | | | | |
| | | | | | | | | |
| | | | | | | | | |
| | | | | | | | | |
| | | | | | | | | |
| | | | | | | | | |
| | | | | | | | | |
| | | | | | | | | |
| | | | | | | | | |
| | | | | | | | | |
| | | | | | | | | |
| | | | | | | | | |
| | | | | | | | | |
| | | | | | | | | |
| | | | | | | | | |
| | | | | | | | | |
| | | | | | | | | |
| | | | | | | | | |
| | | | | | | | | |
| | | | | | | | | |
| | | | | | | | | |
| | | | | | | | | |
| | | | | | | | | |
| | | | | | | | | |
| | | | | | | | | |
| | | | | | | | | |
| | | | | | | | | |
| | | | | | | | | |
| | | | | | | | | |
| | | | | | | | | |
| | | | | | | | | |
| | | | | | | | | |
| | | | | | | | | |
| | | | | | | | | |
| | | | | | | | | |
| | | | | | | | | |
| | | | | | | | | |
| | | | | | | | | |
| | | | | | | | | |
| | | | | | | | | |
| | | | | | | | | |
| | | | | | | | | |
| | | | | | | | | |
| | | | | | | | | |
| | | | | | | | | |
| | | | | | | | | |
| | | | | | | | | |
| | | | | | | | | |
| | | | | | | | | |
| | | | | | | | | |
| | | | | | | | | |
| | | | | | | | | |
| | | | | | | | | |
| | | < | | | | | | |

The Free Universal Construction Kit

We (F.A.T. Lab and Sy-Lab) neither sell nor distribute physical copies of the *Free Universal Construction Kit*. Please do not ask us to do so. Individuals seeking their own physical copies of the Kit, in whole or in part, are encouraged to download our files and reproduce them with open-hardware desktop 3D printers like the Makerbot, RepRap, Ultimaker, or Printrbot. Alternatively, copies for private use may be available from a personal fabrication service bureau; for awesome service, international/anywhere shipping and quick turnaround, we highly recommend Ponoko.com for personalized 3D printing in a wide variety of materials. Shapeways and QuickParts are good, too. You may also find a 3D printer in the architecture, industrial design, and/or mechanical engineering departments of your local university. Please note that our license for the *Free Universal Construction Kit* prohibits commercial use of these designs in mass production; note, however that we encourage individuals to contract with fabrication service bureaus for the creation of personal copies. For more information, see our license and disclaimers, below.

Implementation

The *Free Universal Construction Kit* comprises nearly 80 two-way adapters. These allow each of the different construction toys (Lego, Tinkertoy, Fischertechnik etc.) to interface with any of the other supported systems. Prior to modeling, the dimensions of the various toy connectors were reverse-engineered with an optical comparator fitted with a digital read-out accurate to less than one ten-thousandth of an inch (0.0001in., or 2.54 microns). The resulting precision ensures that the *Free Universal Construction Kit* “actually works”, enabling tight snap-fits between custom and commercial components.

In addition to its many one-to-one adapters, the *Free Universal Construction Kit* also includes a special fist-sized Universal Adapter Brick which provides connectivity between all of the supported construction systems:

Producing physical prints from our provided 3D models prompts certain fabrication considerations. According to Wikipedia, the precision of Lego pieces is less than 10 microns. As of early 2012, however, standard Makerbot printers have an XY resolution of 100 microns (0.1mm) and a default layer thickness of 360 microns (0.36mm). We thus caution that fabrication of the *Free Universal Construction Kit* with current (2012-era) solutions for DIY 3D printing, such as the Makerbot, Printrbot or RepRap, may lack the precision required for reliable or satisfactory coupling with standard commercial pieces. A great deal depends on how well-tuned the printer is; thus, your mileage may vary. In any case, we expect this situation will improve gradually, but inexorably, in tandem with improvements to these vibrantly evolving fabrication platforms. The artist’s proof shown here was

The Free Universal Construction Kit

created in a UV-cured white resin using a commercial-grade Objet (“polyjet”) 3D printer, which has a horizontal resolution of 42 microns, and a layer thickness of 16 microns. Ponoko.com and other private fabrication services offer printing from Objet machines and other high-resolution devices.

Legal and Commercial Implications

Consider the frustrating experience of purchasing a new computer (a Mac, say) and discovering that it will not play your aunt’s Windows Media video of your little cousins. Likewise, imagine your aunt’s corresponding annoyance when she finds that her PC will not play the Apple Quicktime video you sent her of your cats. This humiliating little episode isn’t an accident; it’s just a skirmish in a never-ending battle between giant commercial entities, played out, thousands of times every day, in exactly such micro-punishments to customers like you. If you’re well-informed, you may happen to know about VLC – a free, open-source video player, developed by independent hackers as a grassroots remedy for exactly this problem. Until the advent of ubiquitous 3D printing, software remedies like VLC weren’t readily available for hardware products, like toys. That’s changing. Today’s manufacturers have little or no intrinsic motivation to make their products compatible with anyone else’s. Indeed – despite obvious benefits to users everywhere – the implementation of cross-brand interoperability can be nearly impossible, given the tangled restrictions of patents, design rights, and trademarks involved in doing so. So we stepped up. *The Free Universal Construction Kit* is the VLC of children’s playsets.

As we can see from the example above, interoperability is a question of power and market dominance. Most market leaders regard interoperability as an anti-competitive nuisance, a regulatory check on their ambition, or a concession to the whining of lesser players. Quite simply, interoperability is the request of the disenfranchised. And which end-user, in so many ways, is less enfranchised than a preliterate child?

The simple fact is that no toy company would ever make the *Free Universal Construction Kit*. Instead, each construction toy wants (and indeed, pretends) to be your only playset. Within this worldview, the other manufacturers’ construction sets are just so many elephants in the room, competing for your attention on the shelves of Toys-R-Us. No longer. The *Free Universal Construction Kit* presents what no manufacturer could: a remedy providing extensible, post-facto syntactic interoperability for construction toys. Let the fun begin!

Some may express concern that the *Free Universal Construction Kit* infringes such corporate prerogatives as copyright, design right, trade dress, trademarks or patents of the supported toy systems. We encourage those eager to enforce these rights to please think of the children

The Free Universal Construction Kit

(or perhaps the Streisand effect) – and we assert that the home printing of the *Free Universal Construction Kit* constitutes protected fair use. Simon Bradshaw et al., writing in “The Intellectual Property Implications of Low-Cost 3D Printing”, conclude that the public is legally allowed to make 3D prints that mate with proprietary parts, especially in cases (the “Must Fit Exception”) where a piece’s shape “is determined by the need to connect to or fit into or around another product”: “Even where a registered design is copied via a 3D printer this would not be an infringement if it were done ‘privately and for purposes which are not commercial’. Both criteria must be met; it is insufficient that copying is not done for profit. Purely personal use of a 3D printer to make items will thus not infringe a registered design.” In fact, the *Free Universal Construction Kit* deliberately avoids patent infringement. Part of our strategy for doing so is our choice to support older (“classic”) playsets: of the ten toy systems supported by the Kit, eight are no longer protected by active (20-year) patents. To take a few examples: Lego was patented in 1958; Lincoln Logs, in 1920; and Tinkertoys, in 1932. There are, however, two instances in which toy systems nominally supported by the Kit are still protected (as of this writing) by active patents: Zoob (patented 1996) and ZomeTool (patented 2002). For the Zoob and Zome systems, please note that we have delayed the release of pertinent adapter models until December 2016 and November 2022, respectively.

The *Free Universal Construction Kit* is simply one “toy” illustration of a coming grassroots revolution, in which everyday people can – with desktop tools – overcome arbitrary restrictions in mass-manufactured physical culture. The burgeoning possibility of freely shared downloadable adapters has significant implications for industries where the attempt to create “technological lock-in” is a common business practice.

For more on this subject, and the legal horizons of reproducing commercial products with home fabrication systems, please see:

- Bradshaw, Simon; A. Bowyer and P. Haufe, “The Intellectual Property Implications of Low-Cost 3D Printing”, 7:1 *SCRIPTed* 5, 2010. Online at www.law.ed.ac.uk/ahrc/script-ed/vol7-1/bradshaw.asp.
- de Bruijn, Erik. “Fab It Yourself: Adapters & Consumer Lock-In”. *Blog.erikdebruijn.nl*, 13 September 2010. Online at <http://blog.erikdebruijn.nl/archives/148-FIY-Fab-It-Yourself-Adapters-consumer-lock-in.html>.
- Hanna, Peter. “The next Napster? Copyright questions as 3D printing comes of age”. *Arstechnica.com*, April 2011. Online at <http://arstechnica.com/tech-policy/news/2011/04/the-next-napster-copyright-questions-as-3d-printing-comes-of-age.ars/>.
- Ross, Valerie. “Can You Patent a Shape? 3D Printing on Collision Course

The Free Universal Construction Kit

With Intellectual Property Law”. *Discover Magazine*, 7 April 2011. Online at <http://blogs.discovermagazine.com/80beats/2011/04/07/can-you-patent-a-shape-3d-printing-on-collision-course-with-intellectual-property-law/>.

- Weinberg, Michael. “3D Printing Settlers of Catan is Probably Not Illegal: Is This a Problem?”. *PublicKnowledge.org*, 28 January 2011. Online at www.publicknowledge.org/blog/3d-printing-settlers-catan-probably-not-illeg.
- Weinberg, Michael. “It Will Be Awesome if They Don’t Screw it Up: 3D Printing, Intellectual Property, and the Fight Over the Next Great Disruptive Technology”. *PublicKnowledge.org*, 10 November 2010. Online at www.publicknowledge.org/it-will-be-awesome-if-they-dont-screw-it-up.

In addition to the writers above, we tip our hats to Thingiverse user Zydac, whose related project (a *Duplo-to-Brio track adapter*) [1] led us to these legal writings; to Andrew Plumb (Clothbot) who has probed the legal and practical implications of Lego-compatible bricks [2] for some time; and to Daan van den Berg, who has explored [3] 3D-printed remixes of branded forms as a mode of critical artistic practice.

License and Disclaimers

The *Free Universal Construction Kit* and its associated media are licensed under and subject to the terms of the Creative Commons Attribution-NonCommercial-ShareAlike 3.0 Unported License (<http://creativecommons.org/licenses/by-nc-sa/3.0/legalcode>). The official URL for the *Free Universal Construction Kit* is <http://www.ffff.at/free-universal-construction-kit>. You are free to copy, distribute and transmit the Kit, and to remix and/or adapt the Kit; in doing so, you must attribute the Kit to “F.A.T. Lab and Sy-Lab”, and include a link to the project using the URL above. We especially welcome extensions to the Kit which provide compatibility with as-yet-unsupported play systems. Please note that extensions to the Kit require the same or similar license. You may not use the Kit in commercial mass production; however, we permit individuals to contract with fabrication service bureaus (e.g. Ponoko, Shapeways, etc.) for personal copies.

Lego®, Duplo®, Fischertechnik®, Gears! Gears! Gears!®, K’Nex®, Krinkles®, Bristle Blocks®, Lincoln Logs®, Tinkertoys®, Zome®, ZomeTool® and Zoob® are trademarks of their respective owners.

The *Free Universal Construction Kit* is not associated or affiliated with, or endorsed, sponsored, certified or approved by, any of the foregoing owners or their respective products.

The Free Universal Construction Kit

We are not a commercial company; we are artists, hackers and activists. The Kit is not a product; it is a provocation. F.A.T. Lab and Sy-Lab, in cooperation with Adapterz LLC, (1) perform solely the service of publishing the *Free Universal Construction Kit*, (2) do not participate in any production, public manufacture or sale of the items displayed here, and (3) offer no opinion, warranty or representation as to the safety, quality or functionality of the Kit. The F.A.T. Lab, Sy-Lab and Adapterz LLC therefore offer no warranty of any kind, express or implied.

Please cite the *Free Universal Construction Kit*, and/or this article, as follows: Free Art and Technology [F.A.T.] Lab and Sy-Lab. "The Free Universal Construction Kit." Fffff.at, 20 March 2012. <<http://fffff.at/free-universal-construction-kit>>.

Warning: Choking Hazard!

Small parts. Not for children under 3 years.

Credits, Contact and Acknowledgements

For press or other inquiries about the *Free Universal Construction Kit*, please contact info@adapterz.org. The Kit was conceived and developed by the F.A.T. (Free Art and Technology) Lab in collaboration with Sy-Lab, and is represented, for legal purposes, by Adapterz, LLC. The Kit's "advertisement" video was created by Riley Harmon.

The creators express gratitude to: our families; our lawyers; the children appearing in our demonstration video, and their families; Jean Aw, Eric Brockmeyer, David Familian, Andy Flowers, Michael Joaquin Grey, Mark Gross, Riley Harmon, Marcie and Lawrence Hayhurst, Allie Oswell, Eric Paulos, Bre Pettis, Kent Sheely, Michael Weinberg, and the STUDIO for Creative Inquiry. The Kit files are sportingly hosted by Thingiverse.com.

Notes

[1] Cf. <http://www.thingiverse.com/thing:4041>.

[2] Cf. <http://www.thingiverse.com/thing:1405>.

[3] Cf. <http://www.platform21.nl/page/3915/en>.

subpixel

by **F.A.T. Lab** April 2012

<http://fffff.at/subpixel/>

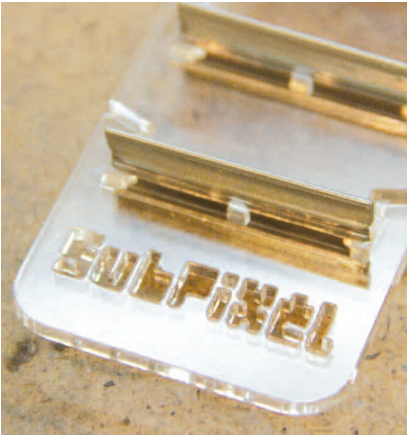

subpixel is a subway advertisement upgrade kit. *subpixel* is built from laser-cut acrylic, rubber bands, and nine razor blades. In two quick swipes, it transforms a small patch of subway advertisement from a “one-way, unending flow of shit” [1] into an 8×8 grid of pixel stickers, ready for two-way interaction with the public. Download the files for laser cutting here: <<http://fffff.at/files/2012/04/subpixel.zip>> Initial tests involved minor modifications to a mainly white poster, using classic icons like the I-beam text selection cursor. The individual pixels proved just as useful for expression as the negative space. Keep your eyes open for a single removed pixel as an indicator of a prepared poster, as the grid itself can be hard to see.

Notes

[1] Sean Tejaratchi, in *Crap Hound*, Issue 6, July 1999.

Enforce!

by Geraldine Juárez April 2012

<http://fffff.at/enforce/>



I was helping out recently with the final touches of the Spanish version of a very cool research that focuses on copyright enforcement, piracy and copy cultures: *Media Piracy in Emerging Economies*. [1]

The book's summary reads: "By locating piracy within histories of non-elite media practices, we have tried to avoid definitions of piracy as theft or crime and focus instead on how pirate practices weave into existing social relations while at the same time transforming them."

So language is power and when it comes to naming phenomena related to culture, internet and copying, the struggle over language has resulted in interesting misuses that has led to labels like pirates, whom I salute!

Those who want to control the way our culture propagate started a very vicious trend years ago by referring to the very normalized practice of copyright infringement as "theft". There have been many attempts to explain why this is not the case. Many. At this point most people know (even supreme courts!) that infringement does not equal theft – yet there is lot of stuff that makes your eyes bleed and end up distorting the debate.

ENFORCE! is a corrective bookmarklet that force your webpage to refer to copyright infringement, copying, monopoly and culture by its proper names. Drag the bookmarklet to your browser toolbar and enforce at all times needed!

Here *ENFORCE!* is tested on a classic Lorem Ipsum:

- You wouldn't steal a car.
- You wouldn't steal a handbag.
- You wouldn't steal a mobile phone.
- You wouldn't steal a DVD.

Enforce!

Downloading pirated films is stealing.
Stealing is against the law.
Piracy: It's a crime.

... becomes:

You wouldn't **copy** a car.
You wouldn't **copy** a handbag.
You wouldn't **copy** a mobile phone.
You wouldn't **copy** a DVD.
Downloading pirated films is **copy*ing*.
**copy*ing* is against the law.
Piracy: It's **culture**.

Steal the disciplinary code:

```
javascript: function
htmlreplace(a,b,element) {if (!element) element=document.body; var
nodes=element.childNodes; for (var
n=0; n<nodes.length; n++) {if (nodes[n].nodeType===Node.TEXT_NODE) {nodes[n].tex
tContent=nodes[n].textContent.replace(new
RegExp(a, 'gi'), b); } else {htmlreplace(a,b,nodes[n]); }} htmlreplace('steal', '
*copy*'); function
htmlreplace(a,b,element) {if (!element) element=document.body; var
nodes=element.childNodes; for (var
n=0; n<nodes.length; n++) {if (nodes[n].nodeType===Node.TEXT_NODE) {nodes[n].tex
tContent=nodes[n].textContent.replace(new
RegExp(a, 'gi'), b); } else {htmlreplace(a,b,nodes[n]); }} htmlreplace('theft', '
*infringement*'); function
htmlreplace(a,b,element) {if (!element) element=document.body; var
nodes=element.childNodes; for (var
n=0; n<nodes.length; n++) {if (nodes[n].nodeType===Node.TEXT_NODE) {nodes[n].tex
tContent=nodes[n].textContent.replace(new
RegExp(a, 'gi'), b); } else {htmlreplace(a,b,nodes[n]); }} htmlreplace('stealing
', '*copying*'); function
htmlreplace(a,b,element) {if (!element) element=document.body; var
nodes=element.childNodes; for (var
n=0; n<nodes.length; n++) {if (nodes[n].nodeType===Node.TEXT_NODE) {nodes[n].tex
tContent=nodes[n].textContent.replace(new
RegExp(a, 'gi'), b); } else {htmlreplace(a,b,nodes[n]); }} htmlreplace('a
crime', '*culture*'); function
htmlreplace(a,b,element) {if (!element) element=document.body; var
nodes=element.childNodes; for (var
n=0; n<nodes.length; n++) {if (nodes[n].nodeType===Node.TEXT_NODE) {nodes[n].tex
tContent=nodes[n].textContent.replace(new
RegExp(a, 'gi'), b); } else {htmlreplace(a,b,nodes[n]); }} htmlreplace('intellec
tual property', '*intellectual monopoly*');
```

Notes

[1] Joe Karaganis (Ed.), *Media Piracy in Emerging Economies*, SSRIC books 2011.
Available online at <http://piracy.americanassembly.org/the-report/>.

ADDIE WAGENKNECHT **Minister Of Propaganda**

Addie Wagenknecht was born during the Reagan administration in Portland, Oregon. At sixteen she fled to New York City where she studied photography under Mary Ellen Mark. Soon after she learned where to get very expensive haircuts. For the following two years, she hitchhiked around the world alone documenting places and people with her camera, before returning to New York City in 2005. There she completed a Masters at New York University as a Wasserman Scholar and shortly after held a fellowship at Eyebeam Atelier, CultureLabUK and more recently at HyperWerk Institute for Post-Industrial Design and Carnegie Mellon University under Golan Levin at The Frank-Ratchye STUDIO for Creative Inquiry.

Her research, collaborations and projects are documented in a number of academic papers, books and magazines such as the Economist, Popular Mechanics, MIT Technology Review, Gizmodo, Slashdot, Engadget, Heise, ARTnews and Der Standard. Most recently she has exhibited at Museumsquartier Vienna, The Istanbul Biennial, Eyebeam NYC, and Rua Red Dublin.

She lives in IRC channels and the Internet. Through her artistic and scientific practices she hopes to challenge the status quo and create a sense of bittersweet irony (preferably both at once).

<http://placesiveneverbeen.com>

BRICKiPhone

by Addie Wagenknecht April 2012

<http://ffff.at/brickiphone/>



BRICKiPhone is a completely functional iPhone 4/4s upgrade case. See, we know you carry the most ubiquitous device of the yuppie class. You probably also have some really ugly ‘protection cover’ on it, when all you ever wanted in life was to go back to the day anyway, right? Solved.

BRICKiPhone is built from four 3D printed pieces. Insert iPhone earplugs, an iPhone 4/4s and go. It snaps together to transform your iPhone into the hottest thing since the last time people rocked bricks (including the coveted belt clip). Since it prints in four pieces it can be printed at home with the 3D printer of your choice. FAT 3D files available for download here:

<<http://ffff.at/files/2012/04/brick-phone.zip>>

BRICKiPhone is licensed under a Creative Commons Attribution-NonCommercial-ShareAlike 3.0

The Optimization of Parenthood

by Addie Wagenknecht May 2012

<http://fffff.at/attention-breeders/>

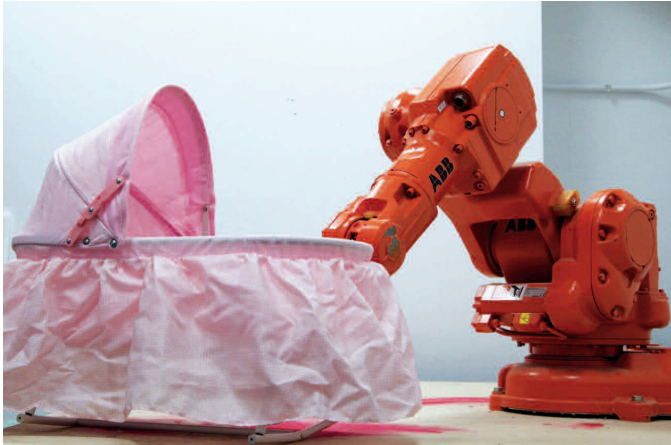

The Optimization of Parenthood is a robot arm which reacts whenever a baby placed in the bassinet cries or awakes from sleep. The arm will speed up if the baby cries and it can also offer a bottle of milk or a favorite toy. Broke parents are often pigeonholed into being full time parents, the cost of childcare sucks every penny away so even if they want to continue their creative work, they can't economically swing it. Its often not so much a choice as it is what we call "The Default to Suck". As a result, the parent, and in reality, almost always the mother, loses the very creative practice they spent an entire life building. The result? We end up on medication, angry, depressed and/or bitches who need a shower.

If however, we could eliminate much of the routine, tedious, monotony of parenting while still continuing a creative practice we will have optimized the process of parenting without losing what makes it interesting.

Automatic repetitive parenting task can be transferred to devices, without affecting 'the development of the baby' while still letting the parent live up to their fullest breeder and artistic potential.

Winning.

This project was developed with support from the STUDIO for Creative Inquiry at Carnegie Mellon University and created at the Digital Fabrication Laboratory, (dFab), CMU School of Architecture with Technical Assistants from Madeline Gannon.

Limited Editions of Unlimited

by **Addie Wagenknecht** May 2012

<http://fffff.at/limited-editions-of-unlimited/>

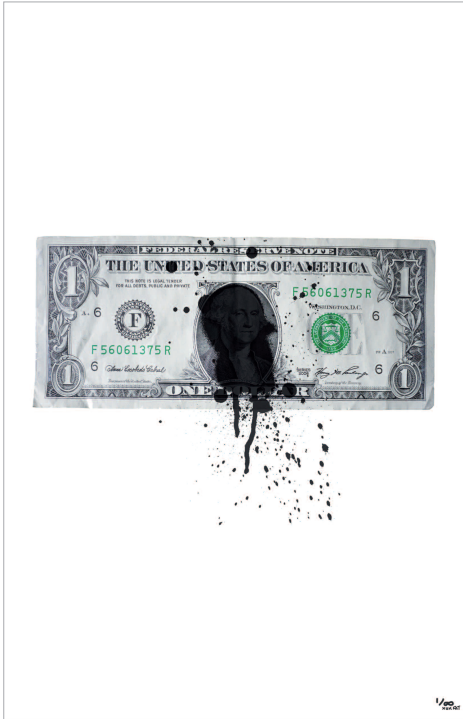

An artwork's value has typically been determined by (superficially) limiting the supply or editions of a piece as determined by the artist, gallery and collectors in order to create a false scarcity.

Art is only valuable if it changes society. Impacting society is only possible if it becomes part of culture. Culture can only be rapidly affected when done in a viral fashion.

Currently, art supply chains often create the opposite of a cultural revolution by only allowing the elite to buy or see collections. At F.A.T. labs, I want to create and distribute to a new contextualization of art and culture through the use of open licenses, open ideas and open art. A disintermediation of The Art World is starting now.

Limited Editions of Unlimited is a F.A.T. bi-annual artwork series which will be released and available online for free. Download and print the first in the series here: <http://fffff.at/files/2012/06/one_of_.pdf>.

Editioned Signed Prints are available by contacting the artist directly. Then what...? Put it on your walls, on buildings, hang it up in the MoMa, give to your friends, your Grandma, lick it, eat it (maybe it taste good)... We want to see us everywhere.

F.A.T 3D Swag

by **Geraldine Juárez** June 2012

<http://fffff.at/f-a-t-3d-swag/>

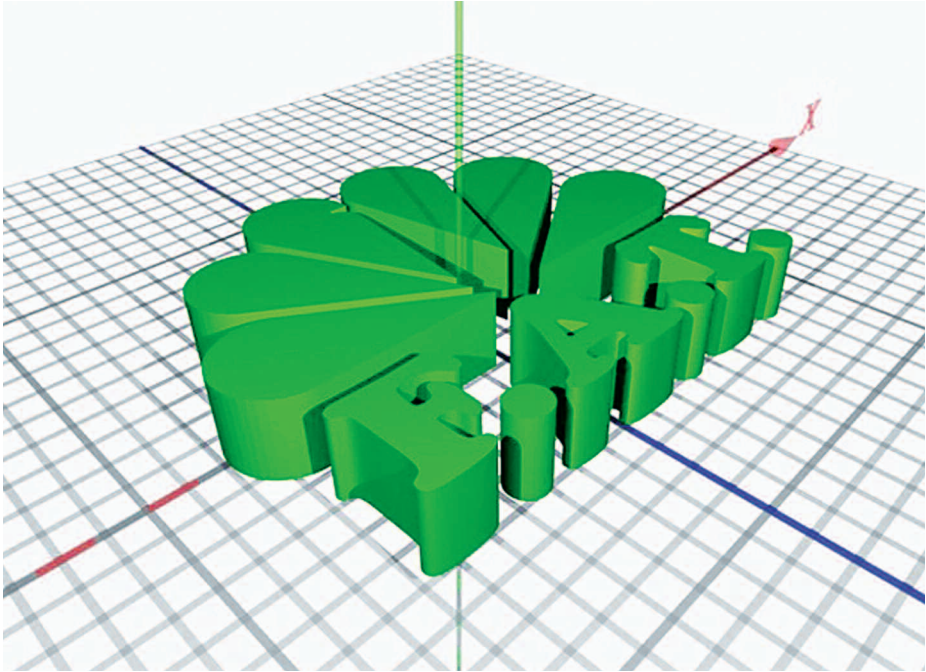

Download, remix and print you copies of the F.A.T official 3D swag in any dimension!

Stl files available at <<http://fffff.at/f-a-t-3d-swag/>>.



HOW TO: Licenses Your Artworkz

by Addie Wagenknecht July 2012

<http://ffff.at/how-to-liscenes-your-artworkz/>



Rock Star Artist or nOOB fresh out of art school and your art is wack, losing its viral flav’ because people don’t want any IP popos chasing them down while remixin it? Ok... cool. Let me help you.

HOW TO: LICENSES YOUR ARTZ:

Step 1: Make dope art.

Step 2: Pick a License for your new dope art and download your License icons here:

[<http://ffff.at/files/2012/07/DIY_FAT_License.zip>](http://ffff.at/files/2012/07/DIY_FAT_License.zip).

Step 3: Put your newly FAT Licen\$ed art up on Twitter and Everywhere else.

Step 4: Your art has total cred. “New Media Curators” will be impressed by your mad crazy art makin skillZ!!!!

FOR EXAMPLE: I’mma Let You Finish ok but here’s how it works – lets say you wanta make art that gets you mad cred, but not for big companies, but say ShareAlike so everyone all over this small small world after all can be remixin’ it? BAMMMMMMMM:



but yeah, we know what’s coming,
Possible Example Question from your lawyer:

Dear Fat Lab, What’s the Fine Print?

Because we know you bitches like to read, we got ALL of that up in here for you...

HOW TO: Licenses Your Artworkz

FREE ART AND TECHNOLOGY LICEN\$E [Copyrap Attitude]

Preamble AKA Wrote us a Manual AKA Introducin' It

The Free Art and Technology Licen\$e recognizes and protects the right to party like badass motherfuckers while makin ya'all's work, work for ya. The implementation has been reformulated in order to allow all you bitches to use creations of the human mind in a creative manner, regardless of their types and ways of expression AKA pimpin' AKA makin' more money into no problems AKA Copyrap'.

What we're talkin about is while the public's access to creations of the human mind usually is restricted by the implementation of copyright law, which is fucked up, you know what I sayin, it is favoured by the Free Art and Technology Licen\$e. This licen\$e allows, you know, the use of a work's resources; to establish new conditions for creating in order to increase creation opportunities with ya'all's rap music and stuff you be makin' in the center stage of your vimeo AKA youtube AKA vhx video. The Free Art and Technology Licen\$e grants the right to use a work like a badass motherfucker, and acknowledges the right holder's and the user's rights and responsibility without being wigity-wack, you know, mad skillz equals mad blue chips when ya'all been in this game for years.

So here is what I sayin, the invention and development of digital technologies, Internetz and Free Software have changed creation methods for all ya boyz and girlz: creations can be distributed, exchanged, and transformed, you know what I'm sayin. It's going to allow ya'all to produce common works to which everyone can contribute to the benefit of all the homies, AKA uptopia AKA Free Art AKA mad love to all you all.

The 411 of the Free Art and Technology Licen\$e is to promote and protect these creations of the human mind AKA bad ass motherfuckers AKA fuckin' blue chips according to the principles of copyrap attitude: freedom to use, copy, distribute, transform, and prohibition of exclusive appropriation with rap music.

Definitions AKA da 411

“work” either means the initial work, like the first shit ya'all made, which is hard to do, you know, keepin' shit fresh when everything's been done, so like, the subsequent works from your hood or the common work as defined hereafter goes like this:

“common work” means a work composed of the initial shit ya'all made

HOW TO: Licenses Your Artworkz

and all subsequent contributions to it (originals and copies) which someone might of, you know, like got off of pirate bay or some shit. The initial author is the one homeboy or girl who, by choosing this licen\$e, defines the conditions under which contributions or mashups from any other of all you motherfuckers are made.

“Initial work” ya’all should know means the work created by the initiator of the common work (as defined above for you motherfuckers), the copies of which can be modified by whoever wants to al’right

“Subsequent works” basically means the contributions or art made by ya’ll who participate in the evolution of the common work with very little weed by exercising the rights to reproduce, distribute, and modify that are granted by the licen\$e for the shit you be makin.

“Originals” (sources or resources of the work) means all copies or rips of either the initial work ya’all made or any subsequent work mentioning a date when some cracka’ or niggas made it and used by their author(s) as references for any subsequent updates AKA bad ass motherfuckin’ interpretations AKA torrients AKA copies which are gonna piss off some white assholes on the top.

“Copy” means any reproduction of an original as defined by this bad ass motherfuckin’ licen\$e.

THERE RULEZ TO THIS SHIT:

1. OBJECT

The aim of this licen\$e is to define the conditions under which any motherfucker can bum rush this work.

2. SCOPE

This work is subject to copyright law AKA makin art with a hell of a lot of weed access AKA blue chips AKA mad pimpin’ with all you alls hoes. Through this licen\$e its author specifies the extent to which you can copy, distribute, and modify all the shit you be makin.

2.1 FREEDOM TO BE A COPYIN’ (AKA MAKE REPRODUCTIONS)

You have the right to copy this work for yourself, your fellow playa’ or any other person, whatever the badass technique used.

2.2 FREEDOM TO DISTRIBUTE, TO PERFORM IN PUBLIC (WITH RAP MUSIC)

You have the right to distribute copies of this work; whether modified or not, whatever the medium and the place, with or without any charge, know what I’m sayin’, provided that you: attach this licen\$e without any modification to any badass motherfuckin’ copies of this work or indicate precisely where the licen\$e can be found by any and all you all bitches and brothers, specify to the recipient AKA cred AKA whoever

HOW TO: Licenses Your Artworkz

made this shit fresh the first time by usin' the names of the author(s) of the originals, including yours if you have modified the work al'right, specify to the recipient where to access the originals (either initial or subsequent shi you be makin').

The brothers and sisters of the originals may, if they wish to, give you the right to distribute the originals under the same conditions as the copies which is dope.

2.3 FREEDOM TO MOTHERFUCKIN' MODIFY

You have the right to modify copies of the originals (whether initial or subsequent) provided you comply with the following motherfuckin conditions:

basically all you all conditions haz in article 2.2 above, if you distribute modified copies AKA rips AKA put the shit on pirate bay or something; be cool by indicatin' that the work has been modified and, if it is possible, what kind of modifications have been made by ya'all; distribute the subsequent work under the same licen\$e or any compatible licen\$e, you know what I'm sayin'.

The author(s) of the original work may give you the right to modify it under the same conditions as the copies you be rippin'.

3. RELATED TO YA'ALLS RIGHTS

Activities giving rise to author's rights and related rights shall not challenge the rights granted by this licen\$e al'right. Just don't be buggin... Here's what I'm sayin', this is the reason why performances must be subject to the same licen\$e or a compatible licen\$e. Similarly, integrating the work in a database, a compilation or an anthology shall not prevent anyone from using the work under the same conditions as those defined in this licen\$e on the original shit you makin'.

4. INCORPORATION OF THE WORK

Incorporating this work into a larger work that is not subject to the Free Art and Technology Licen\$e shall not challenge the rights granted by this licen\$e. So don't be selling this shit to Google without talkin' to the homies who made it before you eva' had a chance to.

What I'm sayin is if the work can no longer be accessed apart from the larger work in which it is motherfuckin' incorporated, then incorporation shall only be allowed under the condition that the larger work is subject either to the Free Art and Technology Licen\$e or a compatible licen\$e AKA no licen\$e cause this liscen\$e is the best licen\$e.

5. COMPATIBILITY

A licen\$e is compatible with the Free Art and Technology Licen\$e provided it does some of the motherfuckin' followin' shit: it gives the

HOW TO: Licenses Your Artworkz

right to copy AKA dub AKA give to your little brothers girlfriend AKA distribute, and modify copies of the work including for commercial purposes AKA suits AKA crackers at the top, and without any other motherfuckin' restrictions than those required by the respect of the other compatibility criteria; it gotta ensure proper attribution of the work to ya'll who made the shit in the first place and access to previous versions of the work if you know what I'm sayin; it recognizes the Free Art and Technology Licen\$e as compatible (reciprocity AKA pay it forward AKA mad love = mad money fo' life); it requires that changes made to the work be subject to the same licen\$e or to a licen\$e which also meets these compatibility criteria. cool? Cool.

6. YOUR INTELLECTUAL RIGHTS (AKA KEEPIN' THE SHIT YOU MAKIN')

This licen\$e does not aim at denying your author's rights in your contribution or any related right to the shit you be makin'. By choosing to contribute to the development of this common work, you be agreeing to grant all your brothers and sisters the same rights with regard to your contribution as those you were granted by this licen\$e al'right. What I'm saying is conferring these rights does not mean you have to give up your intellectual rights in keepin your shit fresh.

7. YOUR RESPONSIBILITIES (AKA DONT FUCK UP)

The freedom to use the work as defined by the Free Art and Technology Licen\$e (right to copy, distribute, modify) implies that everyone is responsible for their own actions, you gotta be keepin' the chains clean.

8. DURATION OF THE LICEN\$E

This licen\$e takes effect as of your acceptance of its rulez. The act of copying, distributing, or modifying the work constitutes a tacit agreement which is: this licen\$e will remain in effect for as long as the copyright which is attached to the work with or without rap music. If you do not respect the terms of this licen\$e like you would your momma, you automatically lose the rights that it confers if you know what I'm sayin'.

If the legal status or legislation to which you are subject makes it impossible for you to respect the terms of this licen\$e, you may not make use of the rights which it confers and then crazy shit happens like you end up at Guantanamo.

9. VARIOUS VERSIONS OF THE LICEN\$E

This licen\$e may undergo periodic modifications to incorporate improvements by its brothers and sisters (instigators of the "Copyrap

HOW TO: Licenses Your Artworkz

Attitude” movement) by way of new, numbered versions released often, and with some bad ass rap music AKA without shittin on’ eachothers dope spots AKA blue chip motherfuckers.

It goes down like this, if you know what I’m sayin’: Ya’all will always have the choice of accepting the terms contained in the version under which the copy of the work was distributed, or alternatively if things fuck up, the provisions of one of the subsequent versions.

10. SUB-LICENSING

Sub-licen\$es are not authorized by this licen\$e. Any person wishing to make use of the rights that it confers will be directly bound to ya’alls folks of the common work.

11. LEGAL FRAMEWORK AKA BIG SUIT TALKIN 4 REALZ

This licen\$e is written with respect to both Internetz law and the Berne Convention for the Protection of Literary and Artistic Works and was ripped off from the original Free Art License 1.3

<<http://artlibre.org/licence/lal/en>> which some bitches up in France wrote down.

F.A.T. NIKA

by **Geraldine Juárez** July 2012

<http://fffff.at/f-a-t-nika/>

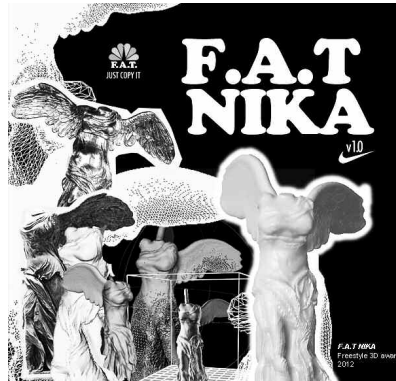

The F.A.T NIKA is a Fake Gucci for the fame economy.

A freestyle replica of Ars Electronica's Golden Nica, [1] one of the most important awards for creativity and pioneering spirit in the field of digital media, the *F.A.T NIKA* is a 3D-modelled object statuette copied from a photograph, a la old school.

The prestigious award can now be easily reproduced infinite times – digitally or physically – and used to acknowledge any creative expression (including yours!), without using the scarcity logic promoted by the art market or relying in the artificial sanctity of juries, curators and gatekeepers.

In 2013, Geraldine Juárez launched the *F.A.T NIKA Award*. The winner of the *F.A.T NIKA Award 2013* is *Computer Rooms* by Goto80, a book that focuses on the context in which computer culture happens.

Download and copy the *F.A.T NIKA v 1.0* here:
<<http://fffff.at/FATNIKA/FATNIKA v1.stl>>.

Notes

- [1] "The Golden Nica is replica of the Greek Nike of Samothrace. It is a handmade wooden statuette, plated with gold, so each trophy is unique: approximately 35 cm high, with a wingspan of about 20 cm, all on a pedestal."
From *Wikipedia*, <https://en.wikipedia.org/wiki/Prix_Ars_Electronica>.

MAGNUS ERIKSSON
Research Research Fellow

I who write here am Magnus Eriksson, long time internet being and currently PhD student in sociology of law writing about the relation between law, digitalization and urban space.

My PhD is a joint collaboration between Lund University, Sweden and University of Macerata, Italy. My thesis is on the role of software in the regulation of urban space. It is an attempt to think digital technologies as material and spatial phenomena in order to better grasp the agency and normativity of emerging technologies that mediate between code and urban environments.

I am especially interested in how urban space and physical activities are regulated and structured to ensure the functioning, capture and compliance with software systems.

I am also holding a research position at The Interactive Institute, a Swedish research institute of interaction design.

Despite a broad range of practices and research interests, as an academic, I feel most at home in sociology, philosophy and media studies.

Outside of academic research, I've been involved in several projects spanning the spectrum from activism to art in the last decade starting with co-founding Piratbyrån in 2003. Other internet projects are too numerous to mention but a few I've been involved in is The Julia Group and Telecomix and the art group F.A.T. Lab. I've also been involved in the hackerspace movement in Malmö, Stockholm and (currently) Gothenburg.

<http://blay.se>

Hot Line Riot from 1982

by Magnus Eriksson September 2012

http://fffff.at/hot-line-riot-from-1982/



"Stationerna överbelastade"

Televerket stoppar heta linjen

Televerket kallade in extrapersonal på lördagen för att stoppa "heta linjen" - de fria telefonlinjer som ungdomar utnyttjar till stora gruppsamtal.

- Men vi har insett att det finns ett behov. Nu undersöker vi om det går att ordna seriösa gruppsamtal, säger Bengt Kjällsson, avdelningsdirektör på Televerket.

Televerket hade tidigare i veckan börjat sprida och stänga linjerna som undviktarna använder. Men under lördagen kallades ett tiotal operativ för att stänga linjerna snabbare.

Det som fått televerket att skynda på var det uppbåd på omkring 1000 personer som samlades på Fridhemsplan och i Riksbanksparken på fredagskvällen.

Polisen var också i kontakt med televerket under lördagen för att få ett stopp på gruppsamtalen.

- Vi började mörka av gruppsamtalen för en månad sedan, men nu har de fått en enorm omfattning säger Bengt Kjällsson. Alla linjer kan inte stängas på en gång, det finns inte tillräckligt med personal. Men om några dagar tåkar televerket mest av gruppsamtalen har upphört.

Många linjer
"Heta linjen" är många linjer. Det är abonnemang som har upphört men där det inte är abonnemang och talbesked. Var för sig 90 till 100 beboende.

- Televerket har varit generöst och låtit hänsynen på kvar flera år efter det att abonnemangsfritt eller abonnemang ett uppbåd, berättar Bengt Kjällsson.

Alla linjer som inte används stängs till en speciell tjänst där linjerna läggs parallellt och ett talbesked kopplas in. När flera personer ringer ett nummer

som uppbåd kan de tala eller skriva med varandra, 15 personer på en gång. Samtidigt hörs hälsningstexten och talbeskedet enligt bakgrunden.

De aktuella telefonnumren sprids med tillstånd. Hälsningstexten och talbeskedet med 15 telefonnummer när de talar på heta linjen. De 15 är också det riktade på fredagskvällen för Dn att han hade 80 nummer som gick till fria linjer.

Raggningar
Så här kan ett samtal inledas på heta linjen.

- Hej, är det någon kille som vill prata med mig.

- Ja, vänta många killar, även är det!

Så varier namn och kontaktörer i luften. Aldern kollar och 12-13 åringar får höra en massa gläpser och uppmanas komma tillbaka när de väntar ut björstadiet.

Fen som får kontakt sätter upp eget telefonnummer för att få prata till sig och en med någon av vänner. Eller också bestämmer man mötesplats och gör tillfälliga beskrivningar av sig själv.

En massa kontaktannonser ritt i luften, alltså. Och det har Televerket utspädd på när verket ska börja sända en organisation för av gruppsamtal.

Pratar av sig
- Vi har gruppsamtalstrukturer redan, men den skulle i så fall automatiseras. Rent praktiskt skulle man kunna ha 50-70

Foto INGEMAR BERLINER

Låt heta linjen få vara kvar! Nämndstör med den uppmaningen cirkulerade bland ungdomar i Norr-Stockholm som varnar om sitt senaste nöje: gruppamtal med 15 personer på telefonlinjen som anknar abonnenter. Ansett, Erling, Sanna Norell, Anders Sund och Ole Lindgren har samlat nämndstör. De får sitta av sina vänner på linjen. Tomas Johansson, Christer Johansson, Johan Nilsson och Tommy Nordström.

offentliga telefonnummer som folk kan ringa när de vill ha kontakt med andra.

- Framför allt måste detta vara något för gamla, sjuka och handikappade som vill prata av sig, och få kontakt med andra, säger Bengt Kjällsson.

Antalet personer i varje gruppsamtal blir dock mindre, 5-10 bäst. Men det skiljer innan dess planer blir verklighet, flera månader bråk för planering och utvärdering.

Tills dess ska det vara ordning och reda i telefonerna.

Vi kan inte låta "heta linjen" fortsätta, förklarar Bengt Kjällsson. Det blir överbelastning på vissa telefonstationer och det kan påverka framkomligheten på andra linjer.

- Dessutom kan vi inte ge den service och hänsyn till folk som av misstag ringer gamla nummer, så länge linjerna är fria, såvitt stöjande ungdomar.

På Fredagskvällen uppstod samtal i Riksbanksparken när nära 1000 ungdomar stömt truff genom heta linjen. Polisers skingrade ungdomarna när de kastade sten från gläpserna över Norr Mälarsstrand.

Foto ROLF SÖDERBERG

It ['] was not the first time that the youths had decided over the hot line to meet at Fridhemsplan [a major central intersection and metro station]. This is how it sounded in an article in *Aftonbladet* the 9th of September.

The new amusement for young people in Stockholm is impropriety group conversation by phone.

You dial a number without subscriber. Between the beeps of Televerket (the state telecommunications authority and public telecoms company) and the automatic voice "please dial..." up to 15 people can simultaneously talk and shout to each other. Here's how it sounded at 8:30 in the morning on number 08 13 00 20: Beep beep beeeeeep... Please dial 90 120 for information... (A murmur of voices, hello, hello, is Goran there?) (Girls voice:) Is there any boy on the line? (Boy:) Yes, me! Are you the one they call "Klark Gable"

Hot Line Riot from 1982

Sure
Oh, is there no one else?
I'm also called Clark Gable...
(Other boys voice:) Goran!
Oh knock it off, there is no Goran
(Girl:) So where are you from?
(Clark Gable:) Enköping.
Are you going to Fridhemsplan tonight?
Well, I don't know.
(Beep beep beep beeeeeep... Please dial...) [2]

But already a few weeks later the number of youths had exploded. Social networks and rumors, like viruses, spread exponentially. One tells another. They tell two more. The four become 8, then 16, 32, 64 and so on and so forth. Not only that. Along the way they may also encounter a true hub, an extremely well-connected supernode. That's when the spreading completely explodes. Such a thing must have happened between the 9th of September and the 17th of September that we now move to.

“A beautiful autumn evening in September 1982 a few dozen motley attired young people gathered at Fridhemsplan: ordinary schoolchildren, no organized motorcycle gangs. Neither the city's few punks and anarchists were represented except by a few delegates. Continuously new youths arrive from the depth of the underground metro station. No one knew where they came from and what their intentions were. They didn't seem to demonstrate for or against anything. They just stood there in loosely connected groups, talking to each other.” Hans-Magnus Enzensberger [3]

Their numbers soon reached a thousand people. Nothing like this had ever been seen: uncontrollable, yet so calm. Perhaps they had a secret plan? Maybe they were under the influence of something? Maybe they were looking for trouble? The police thought it was better to be safe than sorry and decided to disperse the crowd.

They were everywhere, says Commissioner Kjell Andersson. On the roof of the bus shelter and the election booths, in the trees and the power lines. But they scattered when we arrived. [4]

Instead, the crowd moved to the nearby Rååmbshovs park without marching order, without slogans, without predetermined plan. The youths gathered on top of the footbridge at the park, the police close

Hot Line Riot from 1982

behind. A tense situation arise. Someone throws a bottle. That triggers the police to enter.

Fifty police officers with riot gear and dogs move in to disperse the crowd. The youths start to throw rocks, beer cans and bottles from the footbridge. Commissioner Kjell Andersson later describes it as if “it was some sort of mass psychosis. More and more people started throwing things”. [5]

People were hit by batons, bruising occurred. Some claimed they had been bitten by dogs. Four policemen were injured by flying objects. Ten youths were taken into custody and had to be picked up by their parents. By 22 o'clock, the youths had dispersed and everything went back to normal.

Following Day Reactions

The day after this headline shows up in *Aftonbladet*: “Hot Line fans fight with police” (Soccer hooligans was probably the only street violence that they were aware about...).

The teenagers, most of them between 14-18 years of age, didn't know each other [...] They had come into contact through the “hot line” – the new craze that through the mistake of Televerket allows an unlimited number of people to be connected to the same telephone line. [6]

The rumor goes that Televerket are going to shut down the hot line. “We sign protest lists against Televerket. Where should you now be able to get into contact with each other? says Sanna Norelid, 16, from Djursholm [a rich suburb] and she was eagerly supported by her unknown comrades who fought they way forward to sign the lists.” [7] Indeed, commissioner Kjell Andersson fears new riots. “Now we fear what will happen tonight, says Kjell Andersson. If there are new riots with stones-throwing we have to ensure that Televerket stops the “hot line” immediately”. [8]

Svenska dagbladet notes that this was not the only event of its kind with a short notice the day after:

Several large gangs roamed around Stockholm on Friday evening and caused the police great concerns. Several youths were arrested, including in the Rålambshovs park where they indulged in throwing rocks on the police. At the Norrmalm police the detention was almost packed already at 22 in the evening.

Hot Line Riot from 1982

Large gangs also ravaged in Gärdet, on Lidingö, on Ekerö and on Bromstensfältet. [9]

Also *Expressen* acknowledges that it was a messy weekend. Youths have been seen “flipping over cars, breaking windows and burning election posters in Stockholm City”.

At a rock concert in Sergels Torg (the central square) the youths gathered posters and set them on fire. When the police came to arrest them their friends attacked and tried to free them. [10] The youths acted as if possessed by something...

After the initial reactions the news about the incident drown in two major events. On Sunday, the headlines are covered by the massacres in Sabra och Shantila [11] in Lebanon that cost almost 1000 lives.

On Monday, the news flow is dominated by the electoral victory of Olof Palme [12] that marks the end of the Social Democrats after six years as an opposition party.

The Establishment of an Official Line

However, a small notice on the front page of *DN* on Sunday [13] says: “Slutringt på heta linjen” (No more calls on the hot line). Further into the paper [14] we learn that Televerket has called in twenty experts that are going to shut down the numbers used for the hot line. The extra personnel follows directly on a visit from the police that demanded an end to the calls.

The telecoms authority explain how the hot line works:

“The hot line” is actually many lines. It is subscriptions that has ended but where there is a reference tone and the message; please dial 90 120 for information.

Televerket has been generous and let the reference remain several years after the subscription moved or cancelled, says Bengt Källsson. All lines that are not used are connected to a special equipment where the lines are put in parallel and an answering machine has been plugged in. When several people call a number that has ceased they can speak or shout [sic!] to each other. [15]

DN explains further how the youths came across the numbers:

The current phone numbers are spread with lightning speed. Often the youths share the phone numbers when they talk on the hot line. An 18-year-old boy told *DN* on Friday evening that he had a list of 60 numbers that went to hot lines. [16]

Hot Line Riot from 1982

There's our supernode...

However, Televerket are not so heartless that they just shut down the lines. They understand after all that there is a social need, particularly for "old, sick and disabled". Instead they will explore the possibilities of organizing "serious group calls". [17]

An official number is eventually established, but under different house rules. Only 5 people are allowed to talk simultaneously and then only 5 minutes at a time. [18] Presumably the police also have an ear on the wire on Friday evenings. In this way, a social need can be fulfilled without for that matter having unforeseen events occurring in the city on the weekends. The official line later turns into private hot lines that still today can be sighted in small newspaper ads. The private lines haven't caused much fuss, although many certainly have fond childhood memories of them. The only controversy that arose in recent years was a murder in Malmö in the 90's where two men had decided to meet over the hot line and one killed the other. But this time, no one got the idea to blame the medium. Instead, the individuals' psychological orientation and homophobic motives were seen as the cause.

The Great Compromise

The quotes in the beginning of this text are from Hans-Magnus Enzensbergers "Swedish Autumn", one of the few longer accounts of the events and taken from the philosopher's book "Europe, Europe" where he travels around seven European countries and captures the zeitgeist. The hot line riot and its consequences is looked upon by him as a sign of a typical Swedish relationship to the state and trust in social institutions.

He is amazed by the discovery of a new mass medium, what he considers to be a "social innovation of the first order".

It's hardly possible to use modern communication technology more intelligently. I don't know if the city of Stockholm awards a cultural prize. If it does, then the unknown discoverers of the "hot line" have done more to deserve it than all the aspiring performance artists in the kingdom. That should be clear even to the highly paid experts whom for decades have bored audiences with their troubled statements on the aimlessness, weak motivation and anomie of current youth.

The reaction from society was as we know not a prize, but an attack by the police. Enzensberger as German is of course no stranger to violent police action, but still says:

Hot Line Riot from 1982

In the Rålambshovs park there was no illegal squatting; there were no masked faces or molotov cocktails, just a few hundred young people who wanted to talk to each other.

Their crime was simply that they had not called upon any of the responsible institutions available for this purpose. If they had applied to the appropriate office with a request to organize a meeting place for aimless, weakly motivated, anomic young people, they would have been met with subsidies instead of police truncheons. Crowds of social workers, youth counselors and community art workers would have descended on them to help them achieve socially desirable forms of communication.

And indeed, the institutionalization of the hot line arrives, where both Televerket and the police are pulling the strings. A delegation of youths from the hot line meet Televerket and arrive satisfied with the insurance that the youths will get their own “hot line” from the telecoms authority. Enzensberger:

The logic of state intervention is quite clear: first the stick, then the carrot. The social imagination and independent initiative of the young people are crushed in a kind of pinchers movement – repression on the one hand and the state’s embrace on the other. And from that moment on the police dogs can remain in their kennel. The sheep that has found its way back into the fold encounters only helpfulness and understanding.

According to Enzensberger the Swedes think of their institutions as an alien but benevolent power. Clearly, it was unfortunate this thing with the police dogs and the batons, but they just didn’t understand. As soon as the youth delegation had explained they realized that there was a legitimate social need. In this way a “moral immunity” emerges around the institutions where only one with “evil intent” would get the idea to resist their power. Once inside the institutions there is only warmth and helpfulness, life is simple and everything works. Out in the cold you not only risk harm but also that any fun you’re up to can be shut down.

The Power of Media

Enzensberger’s sociological analysis in all glory, but the most interesting theory was still the one developed by the Swedish police. There, all so-called social explanations are completely absent. Here the blame is not put on lack of youth centers, the dismantling of the welfare state or the individualistic culture of capitalism.

Hot Line Riot from 1982

No inherent logic in Swedish society has contributed to these stray youth gangs.

To the Swedish police there were no doubt that the hot line had caused the riot. Not only that, the police believe that the bug in the phone system also explains why in recent times “very large young gangs have emerged in Stockholm” that often has led to vandalism and fights with the police. [19] If only the hot line, this mass psychosis inducing medium, is shut down, the youths will most likely calm down.

Not since the German media theorist Friedrich Kittler claimed that the “so-called man” is only a function of the contemporary technical media standards has anyone taken the power of media so seriously.

Similar conclusions is also drawn in similar debates arising in the 80's. Kung-fu flicks cause the riots in Kungsträdgården and W.A.S.P causes satanist suicide cults.

And of course the Rave Commission and their fight against repetitive hypnotic rhythms the following decade.

However, I don't want to dismiss these moral panics too easily.

That would be to deny the transformative effect of new media.

Sure, everything calms down after a while when society have gotten used to them, but that is only the dust settling after a great battle where social dynamics and power structures have already been altered.

How many wouldn't, like me, have had very different lives if not the internet got in the way sometime during adolescence and opened up whole new worlds? It was almost like a mass psychosis but in a positive sense. The hot line is also an especially interesting case since it redrew the social networks within a limited urban area.

The hot line forms a social sphere that cuts right across schools, regions, classes and center-periphery relations that otherwise divide social groups from each other.

A World on Their Own

What the hot line, the riots in Kungsträdgården (when there still wasn't any surveillance cameras in the city) and at least the early internet have in common is that they all create a social sphere where mostly young people create communities with their own norms and social behaviors, without transparency for either regulatory institutions or social workers – a social sphere that gives the possibility to restart a whole new life instead of the one handed down through social heritage.

Long before Facebook and Google gave direct access to their users personal data to intelligence agencies and long before FRA [20] plugged in their cables and copied all Swedish internet traffic to their databases, the internet was also that kind of social space.

Hot Line Riot from 1982

Before web pages and even internet service providers existed anyone with a phone modem and a computer could call up another computer and exchange information. Thanks to clever phone hacks that made international long distance calls completely free this developed into a global social network long before Carl Bildt in 1994 sent the first email between heads of state to Bill Clinton.

For Kittler it is our media that determine the boundaries of what we can experience and imagine. But this has nothing to do with the content of the media, which he just as McLuhan more or less ignores. It is not the content of novels, movies or philosophical manifestos that exhibit new worlds that inspire to action. For him, it is instead the technical structure of the media that set the boundaries – which connections and messages it allows or filters away, who can transmit, receive or overhear. New media creates new possibilities of communication and social groupings that draw new borders between participant and outsider.

Comparison with Net Politics

Apart from Enzensberger account, references to the event is scarce, despite it having such a unique character. The only mention I find online is the blog *Mothugg* [21] that read Enzensberger's text in 2011 and correctly pointed out that the story of the hot line riot is very reminiscent of today's discussions about net politics – “long before terms such as flash mobs, phreaking, hacktivism, social media, or for that matter, net politics became public property of the Swedish language”. Also the tactic of taking something free, shutting it down and making an official version of it has recently been termed “spotification”. [22]

A contemporary news item about the incident might have been as follows:

Net politics: A flashmob that occurred through social media ended up in a confrontation with the police on Friday evening. The police suspects that a group of phreakers are behind the hacker attack against the telephone system that enabled the anonymous meeting take place where the event was created. The police fear that there is a risk that the anonymous network can be used for organized crime and therefore intends to shut it down.

Monday the 17th of September it is 30 years since the hot line riots.

Hot Line Riot from 1982

Notes

- [1] This text is based on the author's research into the Hot Line riot of 17th of September 1982. Earlier versions consists of an article in *Arbetaren Kultur* and a presentation at Make All at the Technical Museum in Stockholm on the 18th of August. The research is to a large extent based on an analysis on newspapers on microfilm from those days. Links to the scanned newspapers are available on the author's website, and linked in the footnotes.
- [2] Cf. <http://files.blay.se/hetalinjen/.820909-Aftonbladet-9.jpg>.
- [3] Cf. "Hans Magnus Enzensberger om Heta-linjen-upploppet 1982", online at <http://blay.se/hetalinjen.html>.
- [4] Cf. <http://files.blay.se/hetalinjen/.820918-Expressen-18.jpg>.
- [5] Ivi.
- [6] Cf. <http://files.blay.se/hetalinjen/.820918-Aftonbladet-14.jpg>.
- [7] Ivi.
- [8] Cf. <http://files.blay.se/hetalinjen/.820918-Expressen-18.jpg>.
- [9] Cf. <http://files.blay.se/hetalinjen/.820918-SVD-12.jpg>.
- [10] Cf. <http://files.blay.se/hetalinjen/.820920-Expressen-59.jpg>.
- [11] Cf. <http://files.blay.se/hetalinjen/.820919-DN-1.jpg>.
- [12] Cf. <http://files.blay.se/hetalinjen/.820920-Expressen-1.jpg>.
- [13] Cf. <http://files.blay.se/hetalinjen/.820919-DN-1.jpg>.
- [14] Cf. <http://files.blay.se/hetalinjen/.820919-DN-5.jpg>.
- [15] Ivi.
- [16] Ivi.
- [17] Ivi.
- [18] Cf. "Hans Magnus Enzensberger om Heta-linjen-upploppet 1982".
- [19] Cf. <http://files.blay.se/hetalinjen/.820920-SVD-15.jpg>.
- [20] "The National Defence Radio Establishment (Swedish: Försvarets radioanstalt, FRA) is a Swedish Government Agency organised under the Ministry of Defence. The two main tasks of FRA are signals intelligence and support to government authorities and state owned companies regarding IT security." From *Wikipedia*, http://en.wikipedia.org/wiki/Swedish_National_Defence_Radio_Establishment.
- [21] "Enzensberger om Heta linjen-upploppet 1982", in *Mothugg*, August 18, 2011, online at www.mothugg.se/2011/08/18/enzensberger-om-heta-linjen-upploppet-1982/.
- [22] Cf. Magnus Eriksson, "Fighting the 3D Reptiles", March 31, 2010, online at <http://www.blay.se/2010/03/31/fighting-the-3d-reptiles/>.

J3DILLA

by **Geraldine Juárez** October 2012

<http://fffff.at/j3dilla/>

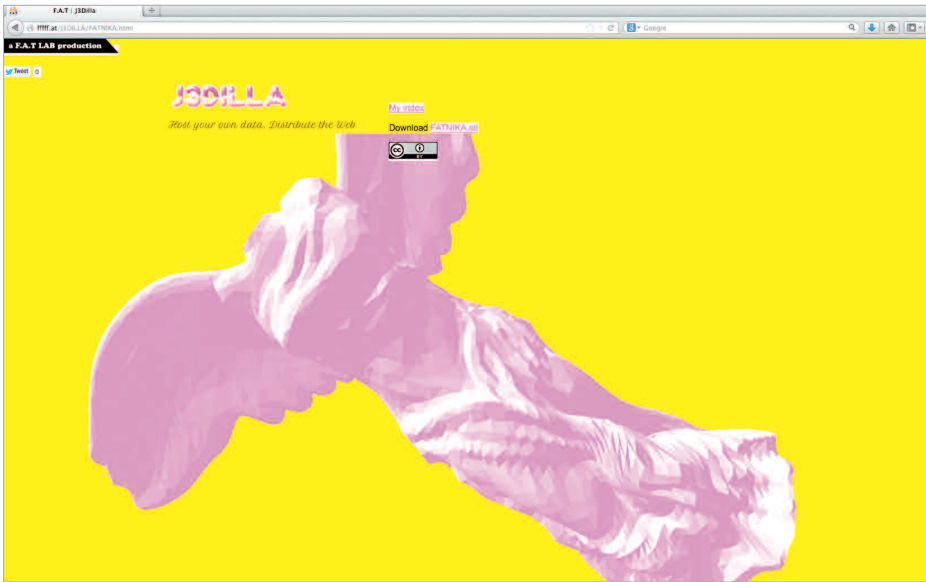

In times of sudden, harsh and never-ending changes to ToS – with which we do not always agree at all (since da man usually don't even ask) – it is always a good idea to host our own data.

J3DILLA is a shell script that makes super easy and painless to generate a list of your .stl files and create pages for display each of them – so you can share them on your own terms.

* Download ZIP package (3.16MB): <<http://fffff.at/jerry/J3DILLA.zip>>

* git it: <<https://github.com/solmarine/J3DILLA>>

Installation:

1. unzip and download the “J3DILLA” directory to your server
2. Drop your .stl models into yourdomain/J3DILLA/myModels
3. Visit yourdomain/J3DILLA/runJ3Dilla.php once
4. Go back to yourdomain/J3DILLA/index.html

Check *J3DILLA* demo at <<http://fffff.at/J3DILLA/>>.

Fake URL Trolling

by **Aram Bartholl** November 2012

<http://ffff.at/fake-url-trolling/>



Never hit RT before they've seen the WWW!

Fake url trolling is super easy but very effective!

- Email/twitter/post a fake shocking story or breaking news to a friend/group.
- Make up a nice long url (wordpress title style) to prolong the shock moment.
- The 404 will make the target wonder if the post was taken down or the link is just broken.

Examples:

- <www.nytimes.com/2012/11/07/movies/google-opens-worlds-first-vertical-movie-theater-on-broadway>
- <www.moma.org/visit/calendar/exhibitions/evan-roth-solo-show-oof/>
- <<http://techcrunch.com/buzzfeed-sold-to-microsoft>>
- <www.fbi.gov/wanted/topten/KATSU/view>
- <<http://ffff.at/how-to-become-a-member-of-fat>>
- <www.nytimes.com/2012/11/07/movies/google-opens-worlds-first-vertical-movie-theater-on-broadway>
- <www.moma.org/visit/calendar/exhibitions/evan-roth-solo-show-oof/>
- <<http://techcrunch.com/buzzfeed-sold-to-microsoft>>
- etc

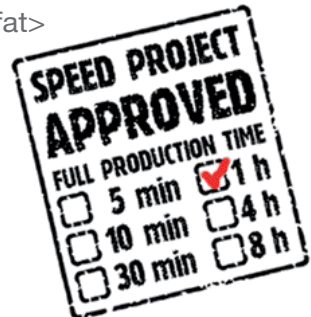

The Instagram Riots of Gothenburg 2012

by Magnus Eriksson December 2012

<http://fffff.at/the-instagram-riots-of-gothenburg-2012/>



Some of you may have heard that we had “Instagram riots” here in Gothenburg a few days ago. [1] Since I live in Gothenburg and have a fascination for media-ignited riots, I wrote this extensive summary of the events.

First of all some context on Swedish riot history. It’s not that uncommon but these riots have been related to two previous riots in particular that’s good to know about. First, the hot line riots of 1982 and second the riots in Gothenburg 2001 when George Bush visited the city.

What happened this time around was that a person (a 17 years old girl attending Plusgymnasiet [2] was suspected and got police protection) started an Instagram account called “gbgorroz” (“gbg” is short for Gothenburg, “orroz” is a swedishification of a turkish word meaning whore) asking people to name and shame the sluts of Gothenburg and what slutty things they have done. The account gained about 6000 followers and posted about a hundred pictures and description about “sluts” of Gothenburg (mostly female but also male, often for being “gays”. Age 12-18) and their alleged sex acts before it was shut down.

The Instagram Riots of Gothenburg 2012

In an unexpected turn of events, the last pictures posted was screenshots of the inbox of the account where you could see who had submitted what “slut” – shaming the shamers.

Somehow it was revealed who was behind the account – or at least someone was accused – and people decided to “take revenge”.

A rumor started spreading that there would be “chaos” at this high school the morning after. And there was even a Facebook event called “World War 3 at Plusgymnasiet”. About 500 people showed up the day after (December 18) and tried to enter the school. I guess most to just watch THE CHAOS unfold. Some were there to beat up the girl that started it (among them people who had submitted to the account and had been exposed in the screenshots). Others to beat up the people who had submitted to the account. Some even might have been there to beat up someone for what they allegedly had done. And yet more just there to take the opportunity to start some fights.

Let me show you what it looked like. [3]

After this, the riots – for some reason, probably many reasons – started drifting to the nearby and centrally located mall, Nordstan. It continued with more fights among the christmas shoppers, who hid inside the stores, and people started jumping on cars and throwing rocks at the police. There was also continual crowds roaming the day after (December 19) at other high schools. I guess either to take more revenge on people involved or continue fights that was not finished the day before. Several high schools was shut down one or two days after to protect students.

In conclusion: I don’t think there really was much of rioting going on, except some stones being thrown at the police. A riot has mostly externally directed energies, towards an outside enemy, or just the surrounding environment in general. This was more a big crowd roaming around looking for people (also in the same crowd) to beat up.

So you had individual fights and beat downs within the crowd itself.

In other words a very inward directed energy. I also think there was lots of different aggressions coming out. One could say that it was a noble cause, reacting against the public shaming of women, but it could just as well have been because people felt that *these particular* girls did not deserve to be humiliated this way or that *these particular* boys were not gays. So I don’t know what to think about that really. Was the reaction against public shaming or against false accusations of promiscuity (which is then still condemned)?

What’s good is that most people have afterwards focused on violence, gender issues, culture around sexuality and bullying, and preventing this kind of behavior, rather than condemning “the internet” for what happened.

The Instagram Riots of Gothenburg 2012

So I think the debate about teenagers and internet use have matured a bit. People are also very fast to report accounts (new ones have popped up), take screenshots as evidence and report them to the police. So we're starting to learn how to react to these things without panic (except the 500 ppl strong mob, that is...). Yesterday (December 20) there was also a demonstration against sexual harassments in the center of the city. That's all from the Instagram riots in Gothenburg, Sweden 2012. As a bonus I give you a video of an angry mob of Justin Bieber fans in Stockholm attacking some provocateurs :) [4]

Notes

- [1] The events have been extensively covered. Cf., for example, "Swedish teens riot over Instagram sex rumours", in *The Local*, December 18, 2012, online at www.thelocal.se/45142/20121218/#.UNQnibYZwzY; "Sweden students riot over Instagram sex insults page", in *BBC News Europe*, December 18, 2012, online at www.bbc.co.uk/news/world-europe-20774640; "Teenagers riot over Instagram sex rumours: Swedish students 'go berserk' at police after hundreds of 'slut' photos posted online", in *Daily Mail Online*, December 18, 2012, online at www.dailymail.co.uk/news/article-2250087/.
- [2] The Plus High School, a privately owned and managed school.
- [3] The author here lists some YouTube videos, some of them removed in the meantime. These links are still active at the time of editing this book (August 2013): <http://youtu.be/Z16Y5u1YBH8>; <http://youtu.be/hGUfEsKqNkw>; <http://youtu.be/b0CleBsrgfk>; <http://youtu.be/PmV408vE3FM>.
- [4] Available at <http://youtu.be/fLVwz93HmMM>.

KATSU

Virtual Research Fellow

“KATSU is a prolific artist, vandal and hacker who emerged in New York City in the late 1990s. He tags both with “KATSU” and has also developed a single stroke skull icon. He has executed a number of high profile pieces that have brought him both recognition and notoriety.

Within the graffiti world, KATSU is often considered an anomaly for conceptually blending vandalism with commercialism and technology. As a result his work includes traditional graffiti, digital media and conceptual artwork.

KATSU is infamous for his use of customized fire extinguishers as a graffiti tool most notably used in his vandalism of the Museum of Contemporary Art in Los Angeles.

In 2011 he replaced approximately 100 phone booth posters around New York City with fake advertisements featuring his tag juxtaposed with famous personalities and corporate logos, such as Nike and MoMA.”

<http://en.wikipedia.org/wiki/KATSU>

KATSU x MINECRAFT

by **KATSU** February 2013

<http://fffff.at/katsu-x-minecraft/>



Recently I've decided to explore where my graffiti can live within the matrix. I've always loved video games and building things so here we are. The future of graffiti for me will be in the form of black hat tactics. *MINECRAFT* offers me a way to connect with my untainted inner youth and create expressions of criminal activity without the police punching me in the head or rival graffiti writers shooting at me. During the construction of this "KA" throw-up, I experienced extreme moments of vertigo when accidentally falling off the top of the letters. I have an incredible ability to truly feel the experience within video games which makes me sweat and scream while playing in first person.

Fuck Google Glass, Apple Eyes Fool!

by KATSU February 2013

<http://fffff.at/fuck-google-glass-apple-eyes-fool/>

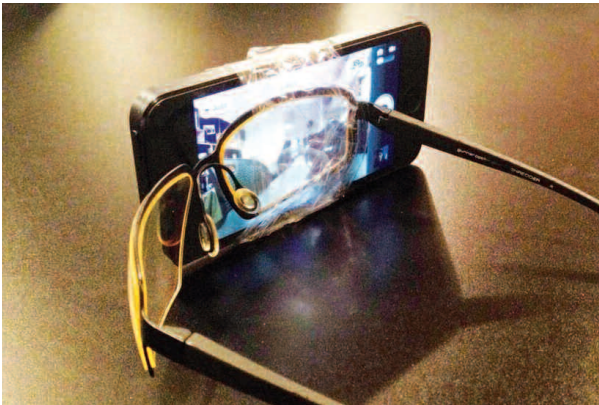

Now why the fuck would I wait to get Google Glass?
What good is a technology that alienates and belittles people?
Don't be scared this is *APPLE EYES* homie.

Webcam Venus

by Addie Wagenknecht and Pablo Garcia March 2013

<http://fffff.at/webcamvenus/>

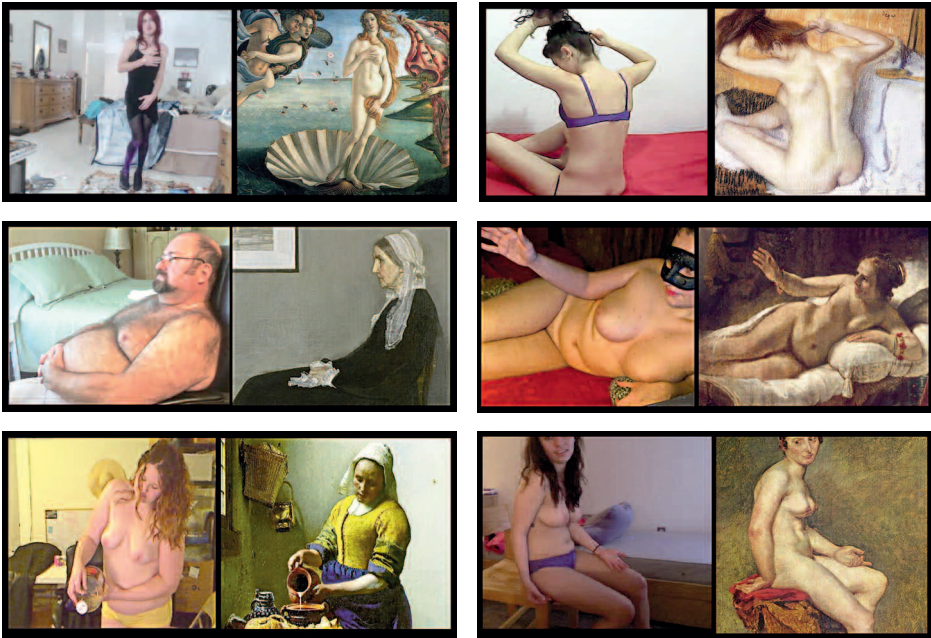

“I know it when I see it.” - US Supreme Court Justice Potter Stewart, on the elusive definition of hardcore pornography, 1964.

If asked if there is a difference between the Renaissance painting *The Birth of Venus* (1486) and a *Playboy* centerfold, most might say it's no contest: one is art and the other pornography. One is of human ideals, the other smut. Are Botticelli and Hugh Hefner really that different? Both project fantasy and erotic imagery through the media of their day. Both are vehicles of gender politics, defining standards of beauty and sexuality. What if adult performers – already mediated sex objects – struck “classic” poses? In *Webcam Venus*, we asked online sexcam performers to replicate iconic works of art. This piece is an experimental homage to both fine art and the lowbrow internet phenomenon of cams. Sexcams use webcams and chat interfaces to connect amateur adult performers with an audience. Users log on to see men, women, transsexuals, couples and groups broadcast their bodies and sexuality live for the public, often performing for money. To create this experiment in high and low brow media, we assumed anonymous handles and spent a few hours each day for a month asking performers: “Would you like to pose for me?”

Webcam Venus

Beauty

What is beauty today? By operating in the language of sexcams, we alter the contemporary ideal of beauty with the ubiquitous display of sexuality online. We challenge the institutions which enforce false perceptions of propriety – via nudity in classical painting – as the only form of acceptable safe-for-work beauty. Publicly presented traditional paintings and sculptures are prevalent with sexuality and gender politics, and yet the display of nudity online is usually defined as ‘pornography’. Amateur adult broadcasters also resist the popular, contemporary definition of beauty. They are not the typical definition of beauty prevalent main stream media: heavily Photoshopped image in the name of advertising, which destroys self image and confidence while encouraging materialism. Sexcam performers are the apotheosis of the most honest parts of us and yet typically the least valued part of a society. Even though they are transmitted virtually, they are real people and they are beautiful.

Public Intimacy

By researching interactive online spaces, we were drawn to those where intimacy goes public – social media, blogs, webcams, chat rooms – and the idea they the content is accessible worldwide. The division between “in real life” (IRL) and “not in real life” (NIRL) is dissolving. Our relationships and most intimate interactions are no longer happening in the same room or even same language. With social media, developing a presence on the internet has become as simple as logging in. Opening your personal world to the outside world frames us each as our own brand – we maintain Twitter feeds, Facebook pages, promote our families, ourselves, we Foursquare every place we go to and Instagram everything we eat. We are becoming a society where we create, produce, and consume all at the same time. In this paradigm of public intimacy, cybersex and sexcams not only seem less deviant, they practically seem inevitable.

Webcam Venus is also about networked cultures and digiphrenia: how technology lets us be in more than one space – or even more than one identity – at the same time. Sexcam performers craft identities through provocative handles, costumes, masks, and interior decoration for the viewing audience. Their display of sexuality is part of this identity. When asked to pose in a “classic” manner, sexcam performers become suddenly self-aware; they want to adjust their hair or surroundings to meet the request. For an instant, *Webcam Venus* reveals the identity that lives just outside the cam space; one where the person must improvise beyond the established protocols of adult performance. We began to see a paradox emerge: IRL (in real life), art nudes are acceptable while naked bodies are

Webcam Venus

inappropriate; NIRL (not in real life), graphic sex acts are acceptable yet de-sexualization on cam was difficult for some performers to maintain.

Process

Before we even began this project, we used email, chat, and VoIP to build our collaborative efforts. The downside, however, was that it limited the types of projects we could attempt. This was our design constraint. We began looking at those tools of collaboration; the same tools to communicate and what those tools say about all of us. We talked to each other through our instant technology. We watched how certain private moments became available to each other; our 7-hour time difference meant mornings met afternoons, nights shared space with early mornings. Personal life, our domestic interiors, all became part of our interactions. We then wondered: “Wait. Where have we seen this before?”

Typical SexCam UI: live cam and chat scroll. All poses were executed through this interface. Models take direction to help strike the pose; other guests can chime in to request their desire.

The models are live, and we propose via text chat scroll: “Would you like to pose for me?” or similar. We – like all guests in the cam rooms – only type in limited but sequential lines of text in a chat scroll. The performer can either interact via typing text lines which appear in the chat scroll along with our comments, or speak directly to guests in audible voice.

The majority of performers do not speak, even though many have a microphone broadcasting ambient sound like background music. If they respond at all – a lot of hours spent being ignored – we start discussing the pose. We show them an image, either through asking them to do a Google search, or a URL we paste in the chat line. Sometimes we make our avatar profile pic the pose we want so they can click on it directly. They pose, holding for 30-60 seconds. They take direction from us to “correct” their pose. The webcam became the image frame.

The performer’s bedrooms or kitchens or bathrooms became the backdrop to these new works and mash-up of histories.

Credits

Webcam Venus was conceived and developed for F.A.T. Lab by Addie Wagenknecht and Pablo Garcia. The project is published under a Creative Commons License.

Hello Bitcoin

by **Geraldine Juárez** April 2013

<http://ffff.at/hello-bitcoin/>

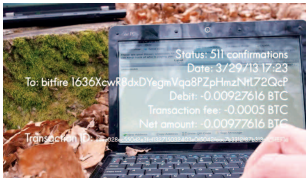
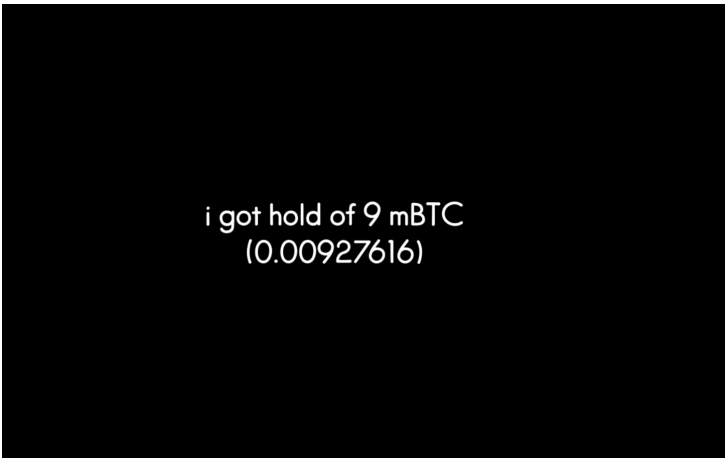

“The real aspect making it into a currency is not when it is spent, but when it is burnt.”
— IRC PROVERB

“Bitcoin is a cryptocurrency where the creation and transfer of bitcoins is based on an open-source cryptographic protocol that is independent of any central authority. Bitcoins can be transferred through a computer or smartphone without an intermediate financial institution. The concept was introduced in a 2008 paper by a pseudonymous developer known only as “Satoshi Nakamoto”, who called it a peer-to-peer, electronic cash system.” [1]
Hello Bitcoin is a performance in which 9 MiliBitcoins (corresponding approximately to 1.11 USD) were removed completely from the BTC supply chain with fire.

Notes

[1] From Wikipedia, <http://en.wikipedia.org/wiki/Bitcoin>.

F.A.T. GOLD**Five Years of Free Art & Technology
Curated by Lindsay Howard**

Eyebeam Art + Technology Center, New York, April 1 – 20, 2013

<http://eyebeam.org/events/fat-gold>



“Don’t let the crazy whimsical nature of this show fool you – the works within are a collectively scathing critique of the commercialization and commodification of the world’s most valuable public good: knowledge.”

— SHANE FERRO [1]

Celebrating more than five years of thug life, pop culture, and R&D, the renegade art organization known as the Free Art & Technology, or F.A.T. Lab, went GOLD. *F.A.T. GOLD*, that is. From April 1–20, 2013, Eyebeam Art + Technology Center in New York presented the acclaimed work of F.A.T. Lab. Organized by Lindsay Howard, Eyebeam Curatorial Fellow, the exhibition encouraged the public to experience and engage with the collective’s groundbreaking projects.

Founded at Eyebeam in 2007 by Evan Roth and James Powderly, F.A.T. Lab has grown to include twenty-five artists, designers and hackers, many of whom have been involved with Eyebeam either as residents, fellows, or collaborators. *F.A.T. GOLD* brings the group back together for the first time as part of Eyebeam’s 15th anniversary series, which marked over a decade of innovative research and progress in the field of new media art. The exhibition featured significant works from 2007 to the present, including new projects launched on opening night. Showcasing a comprehensive and critical selection of the group’s diverse output, the exhibition included video, software, net art, installation, and performance. F.A.T. Lab members also collaborated on new projects that were spontaneously added to the exhibition.

Prior to the opening, graffiti artist KATSU sprayed the façade of Eyebeam’s West 21st Street building with gold paint using his trademark fire

F.A.T. GOLD



extinguisher technique (which accidentally blew onto neighboring galleries, Paula Cooper Gallery and Gagosian). Online projects such as *Shaved Bieber*, *Occupy the Internet*, and *People Staring at Computers* were displayed as installations. In order to show the impressive database of GML tags uploaded in the past five years, Theo Watson conceived of *Every GML (40,000 GML Tags)*, a cascading display of tags in chronological order, from the first ones drawn by Tempt1, to the most recent ones captured by a variety of GML-powered apps. Audiences were encouraged to participate in pieces such as *Existential Emergency Phone* by Randy Sarafan, a phone programmed to call one of 150 possible numbers, connecting the viewer to an unsuspecting person on the opposite line; and *Your face here* by Kyle McDonald, which uses face detection to turn anybody into Google co-founder, Sergey Brin.

F.A.T. GOLD also included a rich program of panel discussions, workshops, and performances, including: a Q&A with F.A.T. Lab moderated by Lindsay Howard, a panel discussion entitled “Rights, Rogues, and Refugees” which explored piracy in emerging economies (organized by Geraldine Juárez), and “Artists as Hackers”, a panel discussion featuring Aram Bartholl, Tobias Leingruber, James Powderly, Evan Roth, and Addie Wagenknecht, moderated by Christiane Paul.

The exhibition traveled to MU in Eindhoven, The Netherlands in November 2013.

Notes

[1] Cf. “One-Line Reviews: Pithy Takes on Gordon Matta-Clark, Elliott Hundley, and More”, in *Artinfo*, April 5, 2013, online at www.blouinartinfo.com/news/story/887850/one-line-reviews-pithy-takes-on-gordon-matta-clark-elliott.

Your Art!!!

by **Aram Bartholl** April 2013

<http://fffff.at/your-art-party-at-fat-gold/>



YOUR ART!!! is an ongoing event organized by Aram Bartholl. Conceived of during Rhizome's Seven on Seven conference in 2012 with Khoi Vinh, Bartholl invites people to build gold chain necklaces and show off their art works on attached smart phones/tablets/etc. On Saturday April 6, 2013, Bartholl organized a *YOUR ART!!!* event at Eyebeam during the *F.A.T. GOLD* exhibition.

F.A.T. Public Access

by **Bennett Williamson and Jamie Wilkinson** April 2013

<http://fffff.at/fat-public-access-recap/>



F.A.T. Public Access was an audio-visual program produced by F.A.T. Fellows Jamie Wilkinson and Bennett Williamson. The show streamed live from Eyebeam every night, and included interviews with artists and collaborators, YouTube show & tell, visual effects, jam sessions, bootleg movie screenings, and documentation of public events. Below you can read Williamson's recap, posted on his blog on April 14. For video and audio documentation, visit: <http://fffff.at/fat-public-access-recap/>.

Last week during *FAT GOLD*, I organized an alternate A/V stream called *FAT Public Access* on which I hosted a series of performances, talks, lectures, and informal chats broadcast live from Eyebeam's gallery space to the web. It's rare that FATLAB gets together in person, and I wanted to capture some of the energy & dialogue that pours forth when we do. I also wanted to use our show (and Eyebeam's equipment!) as a platform to present the work of artists, librarians, curators, musicians, researchers, and friends whose projects dovetail with the values and themes of FATLAB.

4.2.13. Talking Fidonet w/ Kevin Driscoll

Kevin Driscoll joined us from Los Angeles via Skype to discuss Fidonet and other salient topics surrounding his dissertation Hobbyist inter-networking and the popular internet imaginary: Forgotten histories of networked personal computing, 1977-1997. We talk about looking at

F.A.T. Public Access

the ‘people’s history’ of the web and communication technologies as a way to provide the backbone in arguments for user-driven infrastructure in today’s conglomerated networks, duh!

4.2.13. Jamming with Critter & Guitari

Brooklyn-based synth makers Critter & Guitari, nee Chris Kucinski & Owen Osborn, talk briefly about how they manage their fun project that turned into a business, and then jam profusely on Kaleidoloops, Bolsa Basses, Pocket Pianos and other #rare homemade junk, with some friends along for the ride.

4.3.13. FAT History Class with Evan Roth, Aram Bartholl, Addie Wagenknecht

We are joined by FATLAB co-founder Evan Roth to discuss the glory days and birth of F.A.T. Aram and Addie tell us about how they got jumped in, what attracted them to FATLAB in the first place, and everyone fondly remembers their first introductions to the web.

4.3.13. Eric “Ricky” Laska & The Long Cable

Eric came up from Philly with his custom 500-ft XLR cable for a performance that was about 5/6ths cable-slacked interview discussing sound art strategies, 1/6th ‘impulse blasts’ of white noise randomly demonstrating Eyebeam’s decay pattern. Questions from the audience lead to discussions of the myth of “natural coil” and business plans for custom cable companies. <http://ericlaska.com/>

4.4.13. Graffiti Shit Talk Hour with Mike Baca & Fernando Romero

I invited Mike and Fernando to come help me fill the airwaves with some verbal diarrhea for an hour or so, but instead we had a nice talk about their roots in New York’s graffiti world, how they run UR New York, getting beat up by Italian cops, culture vulture artists & advertisers, trying to stay passionate, hanging out with Incubus, working for misguided sustainability campaigns, racking vs. write-offs, and getting bopped via social networks.

4.4.13. Ben Sisto: “Who Let ‘Who Let The Dogs Out?’ Out”

Ben Sisto peels back the onion layers of legal jockeying, heresay, sampling, buyouts, straight up rip offs, and Wikipedia tampering behind the song “Who Let the Dogs Out?” ultimately making the case for it’s rightful place in the public domain.

F.A.T. Public Access

4.4.13. Tech Support Call-In Show with Eyebeam Tech Director Marko Tandefelt

It seems like I only ever have time to talk to Eyebeam's tech director Marko Tandefelt like five minutes before a show is supposed to start and we're desperately searching for a female VGA to male BNC dongle or something ridiculous, so I wanted to carve out some time to just let Marko expound on his profound knowledge of things such as Moog bass pedals, alien sightings, working for Francois K, Finland, and Raspberry Pi, while we take some audience questions and solve questions live on the air.

4.5.13. Andrew Beccone & The Reanimation Library

Andrew Beccone discussed The Reanimation Library, his ever growing library of books full of outdated information and amazing images. We talk about the history of the library and how it morphed from an art project to a public service, it's ongoing expansion through branch locations, regional differences in digging for books, and why we like browsing.

4.5.13. YouTube Open Mic Night

Jamie Dubs served as MC in a casual night of beer, friends, a projector, youtube videos and heckling. A couple people took turns, including Christina Xu. Keywords: FPS cinema, drones, gun pricing, those sword dancing siblings, Die Antwoord, Le1f, dog doo, Ricky "Cassettemaster" Kline, frisbee tricks, 'wet baggystyle' & mudding, Huell Howser, gmcfoشو, the OMG/Skrillex girl, Hot Cheetos & Takis.

Ideas Worth Spreading

by **Evan Roth** April 2014

<http://fffff.at/ideas-worth-spreading/>

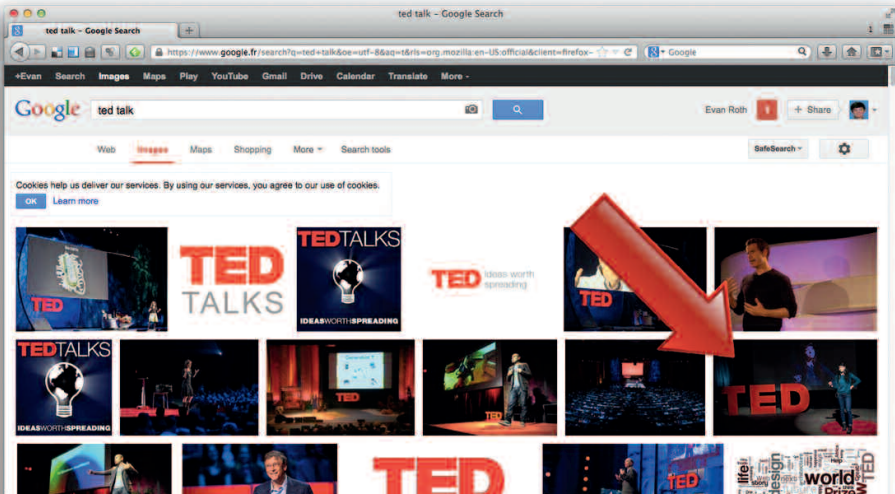

Ideas Worth Spreading is an installation that invites viewers to deliver, document and share TED talks on the Internet. Roth provided a mock TED stage, TED’s promotional images, audience laugh tracks, and video clips of TED audiences, so anyone could edit together a presentation and share it with their networks.

Currently, when you search Google for “TED talks”, a number of results depicting F.A.T. GOLD audience members appear – including one image that’s listed within the top ten search results.

Google Self-Driving Car

by F.A.T Lab April 2013

<http://ffff.at/google-driverless-car/>



“The Internet is the largest experiment involving anarchy in history”

— ERIC SCHMIDT, EXECUTIVE CHAIRMAN OF GOOGLE

“I’ll be the sun shining on you.
Hey Cinderella, step into your shoe.
I’ll be your non-stop lover, get it while you can,
your non-stop miracle, I’m your man.
Get outta my dreams –
Get into my car...”

— SERGEY “OCEAN” BRIN

“In the beginning there was the word, and the word was... super hard to find. So, Google said, “let there be light... and a network of query-processing distributed supercomputers, and googlebots, and page rank and context-aware adverts, and knowledge graph, and a mobile OS, and maps, and a satellite, and Now, and dark fiber, and Glass...”, and on the seventh day, the people said, “OK Google! Enough already. [1] Give it a rest!” But, by then it was too late and Google, had decided to re-design our basic, public infrastructure: the roads. “Hey Google, shouldn’t the people have a say in how we use the public goods?” “Quit acting like a little bitch,” [2] thought Google as it auto-piloted Eric and Sergey to their shareholder meeting in a white, lexus SUV to report their quarterly earnings.”

Google Self-Driving Car

For *FAT GOLD* we decided that we needed to have a Google car on display. However, since the last time we made one, [3] Google's vehicular technology has improved quite a bit. It was immediately apparent that making another Streetview car was simply not going to cut it. We needed to evolve with the technology.

We conferred with the FAT Lab R&D department and they succeeded in making some vinyl decals, and a plastic bucket that spins around.

We feel that we have really outdone ourselves on this one. Our car is virtually indistinguishable from most other self-driving cars on the road. If you want to make your own self-driving car, all you need is some PVC, a few vinyl decals and a beat-up, rental Fiat. And then, of course, you have to create your own *LieDar*...

LieDar is a fake lidar [4] sensor that you can attach to the top of your car to instantly turn it into a self-driving vehicle. Whereas some companies have spent millions of dollars developing the technology to have conversations about the future of transportation, you can butt in for a mere fraction of the cost. To join the multimillion dollar conversation all you need is a 3D printer, and a little gumption.

When your car sports fashionable technology you can experience first-hand what it is like to be a leader in innovation. Everywhere you go people will stop dead in their tracks in wonder and admiration. Children will look back and remember the day they first encountered a self-driving car – your self-driving car! Overnight you can go from merely being a terrible driver to a well-respected and beloved ambassador of the future.

Step-by-step instructions to make your own *LieDar* are available on *Instructables*: <http://www.instructables.com/id/LieDar/>.

Notes

- [1] Cf. Gregory Ferenstein, "Google Fined \$189K For 'One Of The Biggest Data' Privacy Violations In Germany", in *Tech Crunch*, April 22, 2013, online at <http://techcrunch.com/2013/04/22/google-fined-189k-for-one-of-the-biggest-data-privacy-violations-in-germany/>.
- [2] Cf. Sam Biddle, "Sergey Brin Thinks Your Smartphone Is for Girls", in *Gizmodo*, February 27, 2013, online at <http://gizmodo.com/5987431/sergey-brin-thinks-your-smartphone-is-for-girls>.
- [3] Cf. <http://fffff.at/google-street-view-car/>.
- [4] From *Wikipedia*, <http://en.wikipedia.org/wiki/LIDAR>: "Lidar (also written LIDAR or LiDAR) is a remote sensing technology that measures distance by illuminating a target with a laser and analyzing the reflected light. The acronym LIDAR comes either from combining the words light and radar, or from the initial letters of 'Laser Interferometry Detection and Ranging'." All Google Street View Cars are equipped with LIDAR technology. Cf. <http://google-street-view.com/about-google-street-view/>.

Status Update

by KATSU April 2013



As a viral marketing campaign for the *F.A.T. GOLD* exhibition, KATSU plastered an image of Facebook Founder Mark Zuckerberg with a black eye onto the walls at Eyebeam and then all over New York City. The press started asking questions, and KATSU responded: “We’re at the fork in the road with the web. It is being understood as a fundamental part of our evolution as a species. There are some that are fighting to protect privacy, anonymity and freedom and those who are trying to control, monitor and make profits. I want to let people know my beliefs.”

Social Roulette

by Kyle McDonald May 2013

<http://socialroulette.net/>



Twitter Contact

“ A game of chance where your identity is the grand prize. ”

Douglas Rushkoff, Author
Former Facebook User

Sign in to play Social Roulette

Social Roulette has a 1 in 6 chance of deleting your account.

What are you afraid of?

Social Roulette has a 1 in 6 chance of deleting your Facebook account. Everyone thinks about deleting their account at some point, it's a completely normal reaction to the overwhelming nature of digital culture. Is it time to consider a new development in your life? Are you looking for the opportunity to start fresh? Or are you just seeking cheap thrills at the expense of your social network? Maybe it's time for you to play *Social Roulette*. *Social Roulette* is a collaboration between Kyle McDonald, Jonas Lund and Jonas Jongejan.

Rules

There are a few basic rules for playing a successful game of *Social Roulette*.

- You must play with your own account.
- You may only play once a day.

FAQ

Can *Social Roulette* really delete my account?

Yes. While it's very difficult to "permanently delete" a Facebook account, we can completely remove all your posts, friends, apps, likes, photos, and games before completely deactivating it.

Social Roulette

When You Don't Own Yourself

In the short time that *Social Roulette* was active, 393 people pulled the trigger. Given the 1 in 6 odds, approximately 65 people should have had their accounts deleted.

In fact, all 393 people survived.

One side of *Social Roulette* is about discomfort with social networks, or ambivalence about digital identity. This manifested in the tweets and posts from people bashing Facebook or daring each other to play. But now we can reveal the other side: there was never any real danger, because on Facebook your identity is not really yours to play games with.

The Backstory

A few weeks ago, on April 20th, I saw *Friend Fracker*, [1] a piece from Harper Reed and Rafael Lozano-Hemmer developed during Rhizome's 7 on 7 conference. *Friend Fracker* randomly deleted a set of 1 to 10 friends. The element of chance was really refreshing, it made me wonder: is it really our data, our identity, our relationships, unless we can play games with them?

In 2009 the *Web 2.0 Suicide Machine* [2] and *Seppukoo* [3] gave you the chance to delete all your social network activity and your account. That same year *Whopper Sacrifice* [4] asked users to delete 5 friends to get a free Whopper. *Whopper Sacrifice* also posted to your timeline that you made the trade, parading your anti-social behavior in front of your remaining friends.

Deleting an account is one thing, but playing games with it is another. I wanted to combine the element of chance from *Friend Fracker* with the viral anti-social quality of *Whopper Sacrifice*, and up the stakes. That's when *Social Roulette* was born.

I started researching the process of Facebook profile deletion, but was dismayed to discover how difficult the process was. While you can "deactivate" your account, it doesn't mean anything even vaguely similar to "deletion" as we usually mean it. If you really dig into the Facebook support site, there's an obscure form that will let you permanently delete your account after a mandatory waiting period.

This made me feel like my information was hardly mine to delete by hand, much less in an automated way. Sure enough, anyone suggesting otherwise, including *The Suicide Machine*, *Seppukoo*, *Whopper Sacrifice*, and *Friend Fracker* were all shut down shortly after launch.

The Trick

Still, there was something irresistible about the idea of playing russian

Social Roulette

roulette with your Facebook profile. I kept sharing the idea with friends, until finally on May 9th I mentioned it during a F.A.T. Lab panel at CLICK Festival. After the panel, Jonas Lund had an essential insight: the site didn't actually have to "work". From that moment, it was clear that the most important theme wasn't frustration with social networks, but our inability to own our data.

Over the next four hours we developed *Social Roulette*, with Jonas Jongejan joining and creating an animation for the spinning chamber. The experience was carefully crafted.

The visual aesthetic of the site is driven by the startuppy Web 2.0 look of Bootstrap, stolen directly from Kapeli Dash. [5]

The palette was stolen from Facebook (#3b5998, #8b9dc3, #f7f7f7, #dfe3ee) and the Facebook logo was used in the original *Social Roulette* logo. Facebook has strict branding usage guidelines and has been known to take legal action against sites using the word Facebook. We were hoping the logo and palette would be enough to invite attention without the legal action associated with using the word "Facebook".

In keeping with the spirit of the game itself, the quote, testimonials, and screenshot were all fabricated. One avatar chosen for the screenshot was recognizable enough to get a few people questioning the user's involvement. Similarly, we faked the like button [6] (which we quickly removed when the real like count surpassed the fake one).

We asked for as many permissions as possible to create the impression of genuine danger. We started the @roulettenet Twitter as a backup, hinting at the hoax by tweeting a quote from *Dirty Harry* ("do you feel lucky? well, do ya, punk?") just before it's revealed there are no bullets in the chamber.

Facebook's Response

We launched the next day at 11 AM EDT, and had our Facebook API key revoked in less than four hours by an automated system that flagged our app for "creating a negative user experience".

A few hours later Facebook wrote us an email outlining three reasons we were shut down:

1. We auto-posted on behalf of users (even with the warning of the possible post, Facebook doesn't support this behavior).
2. We misused the Facebook branding.
3. We used a fake developer account named John Smith (because none of us were willing to risk our own accounts for real).

We talked over possible directions to head next, everything from making it into a real service that bypasses the Facebook API to just giving up. We

Social Roulette

decided that we would try to abide by Facebook's standards, seeing as we weren't doing anything wrong, and see if the app would be allowed anyway.

It wasn't.

After relaunching a few days later, solving all three issues above, we had our new key revoked in less than three hours. This time, we used my account as the app developer, so I was greeted with an ominous warning that my "account might not be real" when I tried logging in. Facebook never followed up with a description of the conditions we had violated. It turns out even the suggestion of being able to play games with your profile is off-limits.

The Aftermath

Almost no one picked up on the fact that the entire premise of the site was impossible. The exception being a few people on Hacker News. [7] But otherwise the news media was happy to report what we told them. They asked "Does it really delete your account?" and we responded by saying "If the Facebook logo lands on that 1 in 6 spot, you will no longer have access to your account."

Here is the content of our random number function roulette.php:

```
<?php
function roulette() {
    return 1;
}
?>
```

(The bullet always lands just to the right of the barrel.)

When they asked "How does it work exactly?" we said "While we've posted almost all our code to GitHub, we've decided to keep the exact implementation details of the deleteFacebookAccount() private."

Here is the content of deleteFacebook.php:

```
<?php
function deleteFacebookAccount($user) {
    return "deleted";
}
?>
```

Social Roulette

In spite of the hoax, it created some real trepidation, stress, and reflection for a few hundred people. One of my favorite responses came from a friend who played (and survived, of course). He wrote “My heart was thumping. But Now I feel I can delete my Facebook account any time.” *Social Roulette* was a performance disguised as a game. Not only do we talk about deleting our digital identities, but we believe they’re ours to delete, or to play games with. In fact, even suggesting that we own our digital data will get you shut down.

Notes

[1] Cf. www.friendfracker.com.

[2] Cf. <http://suicidemachine.org/>.

[3] Cf. www.seppukoo.com.

[4] Cf. <http://bits.blogs.nytimes.com/2009/01/15/whopper-sacrifice-de-friended-on-facebook/>.

[5] Cf. <http://kapeli.com/dash>.

[6] Using <http://likefake.com/>.

[7] Cf. <https://news.ycombinator.com/item?id=5691295>.



Obama Google Glass Prism Mask

by **Aram Bartholl** June 2013

<http://fffff.at/obama-google-glass-prism-mask/>

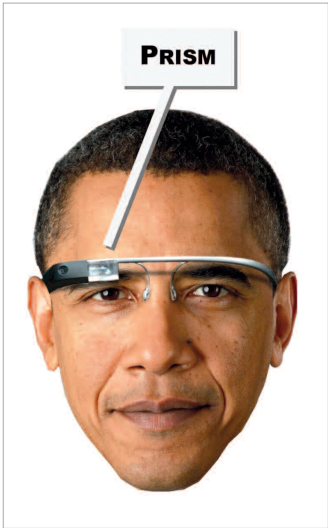

Obama Google Glass Prism Mask is an ironic public space intervention in the form of a DIY mask, commenting on two simultaneous although unrelated events: the hype around Google Glass technology and the unveiling of the clandestine mass electronic surveillance data mining performed by the United States National Security Agency (NSA) since 2007 using a program called PRISM.

In June 2013 Barack Obama visited Berlin. Bartholl wore the mask during a protest, and tweeted photos of himself as Obama in locations such as Google Offices and the STASI museum.

To make your own Obama PRISM Glass mask, just download and print this pdf:

<http://fffff.at/download/Obama-mask-with-Google-Glass-and-PRISM-label.pdf>.

Treddy

by Golan Levin August 2013



Yep, in case you didn't know, it's now possible to 3D print rubber objects. Which is why we've released *TREDDY* – free, open-source software that generates ready-to-print CAD files for custom rubber stamps, using any text or vector logo art.

But *TREDDY* does a whole lot more than generate rubber stamps. It can also be used to generate stamp-like messages on paint rollers and ink brayers; on wheels for skateboards and toys; and on any flat or cylindrical surface. *TREDDY* even has a special option to export 3D models of shoe soles with messages in their tread. No matter the application, *TREDDY* generates “watertight” meshes in the .STL file format, immediately ready for 3D printing.

TREDDY is a F.A.T. Lab project developed at the Frank-Ratchye STUDIO for Creative Inquiry at CMU by Golan Levin, Randy Sarafan, and Jordan C. Parsons. The *TREDDY* rubber-stamp generator is free, open-source software, released under the GNU General Public License. *TREDDY* was created with Processing, an open-source arts-engineering toolkit, using the additional libraries: controlP5, Geomerative, PeasyCam, and toxicLibs. All rubber prints fabricated with the Objet Connex 500 multi-material 3D printer.

LINK Editions

<http://editions.linkartcenter.eu/>

Clouds

Domenico Quaranta, *In Your Computer*, 2011

Valentina Tanni, *Random*, 2011

Gene McHugh, *Post Internet*, 2011

Brad Troemel, *Peer Pressure*, 2011

Kevin Bewersdorf, *Spirit Surfing*, 2012

Mathias Jansson, *Everything I shoot Is Art*, 2012

Joanne McNeil (Ed.), *Best of Rhizome 2012*, 2013

Domenico Quaranta, *Beyond New Media Art*, 2013

In My Computer

Miltos Manetas, *In My Computer # 1*, 2011

Chris Coy, *After Brad Troemel*, 2013

Martin Howse, *Diff in June*, 2013

Damiano Nava, *Let the Right One In*, 2013

Open

Collect the WWWorld. The Artist as Archivist in the Internet Age, 2011.

Exhibition Catalogue. Edited by Domenico Quaranta, with texts by Josephine Bosma, Gene McHugh, Joanne McNeil, D. Quaranta

Gazira Babeli, 2011.

Exhibition catalogue. Edited by Domenico Quaranta, with texts by Mario Gerosa, Patrick Lichty, D. Quaranta, Alan Sondheim

Holy Fire. Art of the Digital Age, 2011.

Exhibition catalogue. Edited by Yves Bernard, Domenico Quaranta

Ryan's Web 1.0. A Lossless Fall, 2012.

By Ryan Trecartin

The F.A.T. Manual, 2013.

Edited by Geraldine Juárez, Domenico Quaranta

LINK Editions is a publishing initiative of the **LINK Center for the Arts of the Information Age**. LINK Editions uses the print on demand approach to create an accessible, dynamic series of essays and pamphlets, but also tutorials, study notes and conference proceedings connected to its educational activities. A keen advocate of the idea that information wants to be free, LINK Editions releases its contents free of charge in .pdf format, and on paper at a price accessible to all. Link Editions is a not-for-profit initiative and all its contents are circulated under an Attribution-NonCommercial-ShareAlike 3.0 Unported (CC BY-NC-SA 3.0) license.

IN CASE OF EMERGENCY



DRILL HERE